

Control Number: 42967



Item Number: 35

Addendum StartPage: 0

RECEIVED

DOCKET NO. 42967

2015 JUL -7 PM 12: 02

CONSOLIDATED APPLICATIONS §
OF LOWER COLORADO RIVER §
AUTHORITY AND CORIX UTILITIES §
(TEXAS) INC. FOR SALE, §
TRANSFER, OR MERGER OF §
WATER AND SEWER FACILITIES §
AND TO OBTAIN CERTIFICATE OF §
CONVENIENCE AND NECESSITY §

PUBLIC UTILITY COMMISSION
FILING CLERK
OF TEXAS

RESPONSE TO ORDER NO. 9

Corix Utilities (Texas), Inc. (Corix) files this response to Order No. 9. Corix has consulted with Lower Colorado River Authority (LCRA), and the Staff of the Public Utility Commission of Texas (Staff), and they support this response.

In Order No. 9, the Administrative Law Judge requested parties to file a clarification regarding certain proposed ordering paragraphs and maps on or before July 1, 2015. Order No. 10 extended the deadline to July 7, 2015. Therefore, this pleading is timely filed.

Ordering Paragraph No. 3 should be revised as follows:

CCN No. 20769 is hereby transferred to Purchaser's CCN No. 21081 in Bastrop, Burnet, Colorado, Lampasas, and Matagorda Counties, Texas. Sewer service areas in the Lometa wastewater system in Lampasas County, the Matagorda Dunes wastewater system in Matagorda County, and the Alleyton wastewater system in Colorado County are also hereby included in Purchaser's CCN No. 21081.

Ordering Paragraph No. 4 should be revised as follows:

The portions of CCN No. 11670 described in the application and shown in the maps of CCN No. 11670 attached to Staff's recommendation are hereby transferred to Purchaser's CCN No. 13227 in Bastrop, Burnet, Colorado, Lampasas, Llano, Matagorda, Mills, and San Saba Counties, Texas. Portions of CCN No. 11670 that are not part of this application are not transferred and remain

35

with LCRA. In addition, water service areas in a portion of the Lometa water system in Lampasas County and the Alleyton water system in Colorado County are hereby included in Purchaser's CCN No. 13227.

Attached to this response is Second Amended Proposed Notice of Approval, revised Map 1, which now indicates the previously uncertificated water service areas and revised Map 2, which now indicates the previously uncertificated wastewater service areas.

Respectfully submitted,



R. Darrin Barker
General Manager
Corix Utilities (Texas) Inc.
Darrin.barker@corix.com
1812 Centre Creek Drive, Suite 207
Austin, Texas 78754
(512) 306-4000

WINSTEAD PC
Carrie Collier-Brown
State Bar No. 24065064
ccbrown@winstead.com
401 Congress Avenue, Suite 2100
Austin, Texas 78701
(512) 370-2868
(512) 370-2850 facsimile

**ATTORNEYS FOR CORIX UTILITIES
(TEXAS) INC.**

CERTIFICATE OF SERVICE

I certify that a copy of this document will be served on all parties of record on the 7th day of July, 2015 in accordance with P.U.C. PROC. R. 22.74.

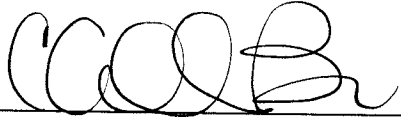

A handwritten signature in black ink, consisting of several loops and a trailing flourish, is written above a solid horizontal line.

ATTACHMENT 1

DOCKET NO. 42967

CONSOLIDATED APPLICATIONS OF LOWER COLORADO RIVER AUTHORITY AND CORIX UTILITIES (TEXAS) INC. FOR SALE, TRANSFER, OR MERGER OF WATER AND SEWER FACILITIES AND TO OBTAIN CERTIFICATE OF CONVENIENCE AND NECESSITY	§ § § § § § §	PUBLIC UTILITY COMMISSION OF TEXAS
--	--	--

SECOND AMENDED JOINT PROPOSED NOTICE OF APPROVAL

This Notice of Approval addresses the applications of Corix Utilities (Texas) Inc. (Purchaser) and Lower Colorado River Authority (Seller) for the sale, transfer or merger of water and sewer systems and transfer of Seller’s Certificates of Convenience and Necessity (CCN) to purchaser pursuant to P.U.C. SUBST. R. 24.109 and 24.112.

Consistent with the above discussion, the Commission makes the following findings of fact and conclusions of law.

I. Findings of Fact

1. On April 29, 2013, Corix Utilities (Texas) Inc. (Purchaser) filed 17 applications with the Texas Commission on Environmental Quality (TCEQ) for the sale, transfer or merger of water and sewer systems of Lower Colorado River Authority (Seller) pursuant to the Texas Water Code (TWC) and TCEQ Rule 291.102 and for approval of the assignment of Seller’s CCN to Purchaser pursuant to TCEQ Rule 291.109 (Applications). The Applications were filed for the following water and sewer systems: Lake Buchanan water system (TCEQ No. 37593-S); Paradise Point water system (TCEQ No. 37594-S); Camp Swift sewer system, McKinney Roughs sewer system, Windmill Ranch sewer system (TCEQ No.37595-S); Alleyton water and sewer system (TCEQ Nos. 37594-S and 37598-S); Spicewood Beach water system (TCEQ No. 37601-S); Matagorda Dunes water and sewer system (TCEQ Nos. 37602-S and 37603-S); Ridge Harbor water and sewer system (TCEQ Nos. 37605-S and 37613-S); Quail Creek water system (TCEQ No. 37606-S); Sandy Harbor water and sewer system (TCEQ No. 37607-S); Smithwick Mills water

system (TCEQ No. 37608-S); and Lometa water and sewer system (TCEQ Nos. 37704-S and 37705-S).

2. The Applications also requested new Certificates of Convenience and Necessity (CCN) be granted to Purchaser and requested approval of the transfer of water and sewer assets to Purchaser.
3. Seller holds CCN No. 20769 for the provision of sewer service in Bastrop, Burnet, Colorado, Lampasas and Matagorda Counties.
4. Seller holds CCN No. 11670 for the provision of water utility service in Bastrop, Burnet, Colorado, Lampasas, Llano, Matagorda, Mills, and San Saba Counties, Texas.
5. Public notice was provided to all affected and interested parties by August 13, 2013.
6. By letter dated December 3, 2013, TCEQ notified Purchaser that a public hearing was not necessary, instructed Purchaser to proceed with the sale and ordered Purchaser to provide final documentation of assets being transferred to Purchaser and along with documents supporting the disposition of customer deposits.
7. On August 29, 2014 Purchaser provided TCEQ the signed sale contract and information regarding disposition of customer deposits.
8. On September 1, 2014, pursuant to House Bill 1600 and Senate Bill 567 of the 83rd Legislature, Regular Session, functions relating to the economic regulation of water and sewer utilities were transferred from TCEQ to the Public Utility Commission of Texas (Commission).
9. The Applications were part of the transfer and are now under the Commission's purview. The Applications were received by the Commission between September 15 and September 22, 2014. The Applications were reviewed pursuant to TWC 13.254 and 13.301 and P.U.C. SUBST. R. 24.109 and 24.112.
10. Staff filed a status update on October 6, 2014 stating that it determined that adequate notice was given for the Applications, and that Purchaser has the financial, managerial

and technical capability to provide the water and wastewater service within the areas being requested in the applications.

11. On October 6, 2014, Staff requested consolidation of the Applications in Docket Nos. 42967, 42968, 42969, 42970, 42971, 42972, 42973, 42976, 42977, 42978, 42979, 42980, 42986, 42987, 43112, 43124, and 43126 pursuant to P.U.C. PROC. R. 22.34(a) because all the dockets stem from the same financial transactions between Purchaser and Seller.
12. On October 15, 2014, the Applications were consolidated into Docket No. 42967, and deemed administratively complete.
13. On February 9, 2015 and February 25, 2015, authorized parties for Purchaser and Seller signed documents consenting to the map and CCN certificates prepared by Staff.
14. On February 26, 2015, Staff recommended that the Applications be approved.
15. No requests to intervene or requests for hearing were filed in this proceeding and there are no disputed issues of fact; therefore, no hearing is necessary.
16. The Commission admits into evidence Staff's recommendation, along with the maps, consents, approved tariffs and Certificates of Convenience and Necessity attached thereto.

II. Conclusions of Law

1. The Commission has jurisdiction over this proceeding pursuant to TWC §§ 13.041, 13.246, 13.251, 13.254 and 13.301 and P.U.C. SUBST. R. 24.109 and 24.112.
2. Seller is a Section 59 of the Texas Constitution Texas River Authority operating pursuant to Chapter 8503 of the Special District Local Laws Code.
3. Purchaser is a water and sewer utility as defined in TWC § 13.002(23).
4. Public notice of the Applications was provided as required by TWC § 13.301(a)(2).

5. The Applications were processed in accordance with the requirements of the Administrative Procedures Act,¹ TWC § 13.301, P.U.C. SUBST. R. 24.109 and 24.112.
6. Seller and Purchaser completed the sale within 365 days from the date of TCEQ's approval of the sale, consistent with P.U.C. SUBST. R. 24.112(e).
7. Purchaser has demonstrated adequate financial, managerial, and technical capability for providing continuous and adequate service to the requested area and any areas certificated to the Purchaser.
8. After consideration of the factors in TWC § 13.246(c), Purchaser and Seller have demonstrated that Purchaser is capable of rendering adequate and continuous service to every consumer within the certificated areas.
9. Purchaser has demonstrated that approval of the Applications is necessary for the service, accommodation, convenience and safety of the public, and serves the public interest.
10. The requirements of informal disposition pursuant to P.U.C. PROC. R. 22.35 have been met in this proceeding.

III. Ordering Paragraphs

In accordance with these findings of fact and conclusions of law, the Commission orders:

1. The Applications for sale, acquisition, lease, rental, merger, or consolidation proposed by Purchaser and Seller pursuant to P.U.C. SUBST. R. 24.109 are approved.
2. CCN Nos. 21081 and 13227 are hereby granted to Purchaser, who shall serve every future customer and applicant for service within the area certified and such service shall be continuous and adequate.
3. CCN No. 20769 is hereby transferred to Purchaser's CCN No. 21081 in Bastrop, Burnet, Colorado, Lampasas, and Matagorda Counties, Texas. Sewer service areas in the Lometa wastewater system in Lampasas County, the Matagorda Dunes wastewater system in

¹ Administrative Procedures Act, TEX. GOV'T CODE ANN. §§ 2001.001–902 (Vernon 2008 & Supp. 2014).

Matagorda County, and the Alleyton wastewater system in Colorado County are also hereby included in Purchaser's CCN No. 21081.

4. The portions of CCN No. 11670 described in the application and shown in the maps of CCN No. 11670 attached to Staff's recommendation are hereby transferred to Purchaser's CCN No. 13227 in Bastrop, Burnet, Colorado, Lampasas, Llano, Matagorda, Mills, and San Saba Counties, Texas. Portions of CCN No. 11670 that are not part of this application are not transferred and remain with LCRA. In addition, water service areas in a portion of the Lometa water system in Lampasas County and the Alleyton water system in Colorado County are hereby included in Purchaser's CCN No. 13227.
5. CCN No. 20769 is hereby cancelled.
6. Pursuant to P.U.C. SUBST. R. 24.106(f), Purchaser shall submit to the Commission evidence of the recording of a certified copy of the maps of CCN No. 21081 in the real property records of Bastrop, Burnet, Colorado, Lampasas and Matagorda Counties no later than the 31st day after the date of this final order.
7. Pursuant to P.U.C. SUBST. R. 24.106(f), Purchaser shall submit to the Commission evidence of the recording of a certified copy of the maps of CCN No. 13227 in the real property records of Bastrop, Burnet, Colorado, Lampasas, Llano, Matagorda, Mills, and San Saba Counties no later than the 31st day after the date of this final order.
8. All other motions, requests for entry of specific findings of fact or conclusions of law, and any other requests for general or specific relief, if not expressly granted herein, are hereby denied.

SIGNED AT AUSTIN, TEXAS THE _____ DAY OF JULY, 2015



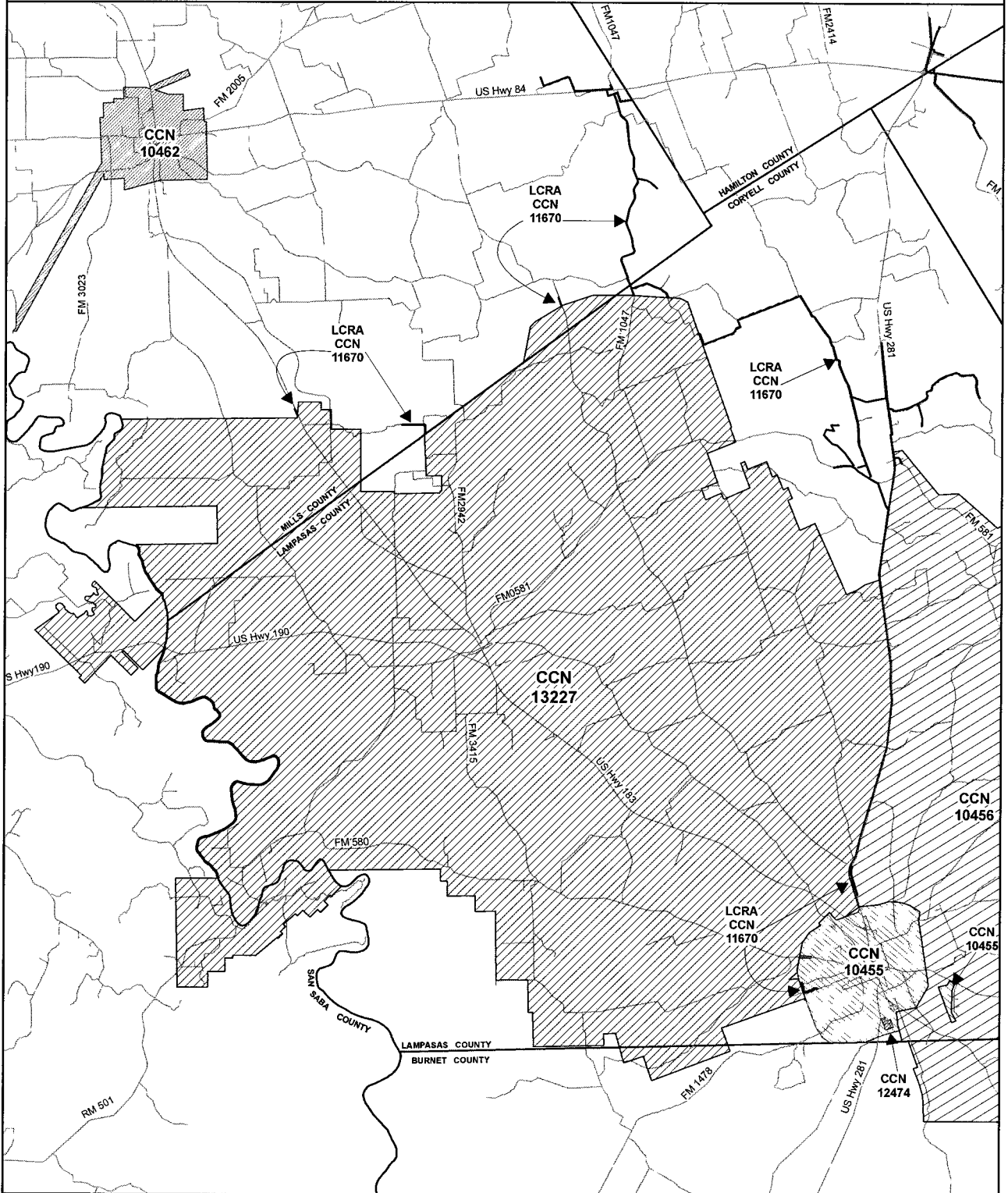

PUBLIC UTILITY COMMISSION OF TEXAS

[]
ADMINISTRATIVE LAW JUDGE



Corix Utilities (Texas) Inc
 Portion of Water Service Area
 CCN No. 13227
 PUC Docket No. 42967
 Transferred a Portion from Lower Colorado River Authority, CCN No. 11670 and Amended CCN in Burnet, Lampasas, Mills and San Saba Counties
 Includes Previously Uncertificated Lometa Water System Area in Lampasas County



Water CCN Service Areas

-  13227 - Corix Utilities (Texas) Inc
-  10455 - City of Lampasas
-  10456 - Kempner WSC
-  10462 - City of Goldthwaite
-  12474 - Woodland Acres POA

Facilities + 200' Water CCNs

-  11670 - Lower Colorado River Authority
-  11525 - Multi County WSC



Public Utility Commission of Texas
 1701 N. Congress Ave
 Austin, TX 78701



Map by Suzanne Jaster
 Date created: Nov 21, 2014
 Project path: n:\gis\projects\applications\43483_42968.mxd

Corix Utilities (Texas) Inc.
 Portion of Sewer Service Area
 CCN No. 21081
 PUC Docket No. 43483
 Transferred a Portion of Lower Colorado River Authority, CCN No. 20769, Amended CCN
 & Includes Previously Uncertificated Matagorda Dunes Wastewater Service Area in Matagorda County

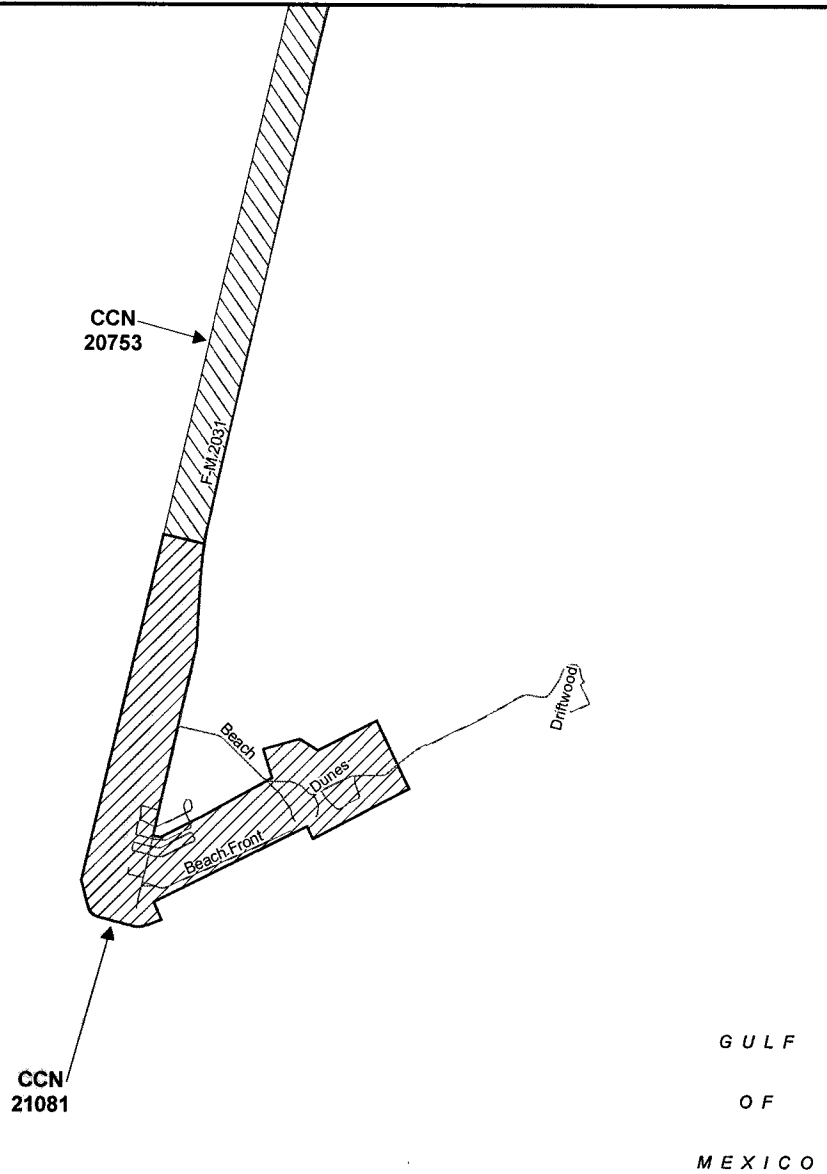

Sewer CCN Service Areas

- 21081 - Corix Utilities (Texas) Inc
- 20753 - Beach Road Utilities Inc

