



Control Number: 35077



Item Number: 140

Addendum StartPage: 0

**Project No. 35077**

RECEIVED  
09 JUL 28 PM 4:20  
PUBLIC UTILITY COMMISSION  
FILING CLERK

**INTERCONNECTION AGREEMENT**

**Between**

**San Marcos Electric Utility**

**and**

**LCRA Transmission Services Company**

**May 26, 2009**

140

+

**INTERCONNECTION AGREEMENT**  
**BETWEEN**  
**SAN MARCOS ELECTRIC UTILITY**  
**AND**  
**LCRA TRANSMISSION SERVICES CORPORATION**

**DATED:** 5/12/09

**INTERCONNECTION AGREEMENT  
BETWEEN  
SAN MARCOS ELECTRIC UTILITY  
AND  
LCRA TRANSMISSION SERVICES CORPORATION**

This Agreement is made and entered into this 12<sup>th</sup> day of May, 2008<sup>9<sup>th</sup></sup>, by and between San Marcos Electric Utility ("City") and LCRA Transmission Services Corporation ("LCRA TSC") each sometimes hereinafter referred to individually as "Party" or both referred to collectively as "Parties".

**WITNESSETH**

WHEREAS, each Party is the owner and operator of transmission and/or distribution facilities and is engaged in the business of transmitting electric energy to the general public within the Electric Reliability Council of Texas; and

WHEREAS, the Parties desire to interconnect their respective transmission and/or distribution systems in the respects, and under the terms and conditions set forth below.

NOW, THEREFORE, in consideration of the premises and of the mutual covenants and conditions herein set forth, the Parties agree as follows:

**ARTICLE I – EFFECTIVE DATE AND TERM**

1.1 This Agreement and any subsequent addendum to this Agreement shall become effective on the date of execution by both Parties. Unless otherwise mutually agreed, this Agreement shall remain in effect initially for a period of thirty (30) years from the effective date, and shall continue in effect thereafter for periods of five (5) years each unless canceled after such initial period or any subsequent period either by mutual agreement or by either Party upon at least thirty-six (36) months written notice to the other party.

**ARTICLE II – OBJECTIVE AND SCOPE**

2.1 It is the intent of the Parties, by this Agreement, to state the terms and conditions under which the Parties' transmission and/or distribution systems will be interconnected and to identify the facilities and equipment provided by each Party at the Points of Interconnection between their systems.

2.2 This Agreement shall apply to the ownership, construction, operation, and maintenance of those facilities which are specifically identified and described in the Facility Schedules which are attached hereto and incorporated herein.

2.3 This Agreement, including all attached Facility Schedules, constitutes the entire agreement and understanding between the Parties with regard to the interconnection of the facilities of the Parties at the Points of Interconnection expressly provided for in this Agreement. The Parties are not bound by or liable for any statement, representation, promise, inducement, understanding, or undertaking of any kind or nature (whether written or oral) with regard to the subject matter hereof if not set forth or provided for herein. This Agreement replaces all other agreements and undertakings, oral and written, between the Parties with regard to the subject matter hereof. It is expressly acknowledged that the Parties may have other agreements covering other services not expressly provided for herein; such agreements are unaffected by this Agreement.

2.4 If the City also takes Transformation Service from LCRA TSC, the City shall execute a separate agreement for Transformation Service, which shall be attached hereto.

### **ARTICLE III – DEFINITIONS**

For purposes of this Agreement, the following definitions shall apply:

3.1 Agreement shall mean this Agreement with all schedules and attachments applying hereto, including any schedules and attachments hereafter made and any amendments hereafter made.

3.2 ERCOT shall mean the Electric Reliability Council of Texas, Inc.

3.3 ERCOT Protocols shall mean the documents adopted by ERCOT, and approved by the PUCT, including any attachments or exhibits referenced in the ERCOT Protocols, as amended from time to time, that contain the scheduling, operating, planning, reliability, and settlement (including customer registration) policies, rules, guidelines, procedures, standards, and criteria of ERCOT.

3.4 ERCOT Transmission Operator shall mean the subset of transmission service providers or transmission and/or distribution service providers (TDSPs) that is charged with continuous communication (7 days per week and 24 hours per day basis) with ERCOT operations and carrying out dispatch instructions directly or on behalf of represented TDSPs and carrying out other functions as described in the ERCOT Protocols.

3.5 Facility Schedule(s) shall mean the addendum(s) to this Agreement that describe the agreement on ownership, control, operation, and maintenance responsibilities of the Parties at the Point(s) of Interconnection.

3.6 Good Utility Practice shall mean any of the practices, methods and acts engaged in or approved by a significant portion of the electric utility industry during the relevant time period, or any of the practices, methods and acts which, in the exercise of reasonable judgment in light of the facts known at the time the decision was made, could have been expected to accomplish the desired result at a reasonable cost consistent with good business practices, reliability, safety, and expedition. Good Utility Practice is not intended to be limited to the optimum practice, method, or act to the

exclusion of all others, but rather to be acceptable practices, methods, or acts generally accepted in the region. Good Utility Practice may include, but not be limited to, conformance with the applicable and consistently applied reliability criteria, standards and operating guides of ERCOT and the NERC, or successor organization(s).

3.7 Independent System Operator shall mean the ERCOT Independent System Operator as defined in the PUCT Substantive Rules.

3.8 NERC shall mean the North American Electric Reliability Corporation or its successor in function.

3.9 NERC Reliability Standards shall mean the mandatory electric reliability standards enforced by NERC.

3.10 Point(s) of Interconnection shall mean the points where the electrical systems of the Parties are connected or may, by the closure of normally open switches, be connected.

3.11 PUCT shall mean the Public Utility Commission of Texas or its successor in function.

#### **ARTICLE IV – ESTABLISHMENT AND TERMINATION OF POINTS OF INTERCONNECTION**

4.1 The Parties agree to comply with NERC Reliability Standards as they relate to the interconnection of their facilities at the locations identified and described in the Facility Schedules which are attached hereto and incorporated herein.

4.2 The Parties agree to interconnect their facilities at the locations, and in accordance with the terms and conditions, specified in the attached Facility Schedule(s). All Points of Interconnection shall be specified in Exhibit "A" and the Facility Schedule(s) attached hereto and made a part hereof. The Facility Schedule(s) shall specify the responsibilities of the Parties with respect to ownership, control, operation, and maintenance of the interconnection facilities.

4.3 Unless otherwise provided in a Facility Schedule, each Party shall, at each Point of Interconnection, at its own risk and expense, design, install, or cause the design and installation of the transmission or distribution facilities (including all apparatus and necessary protective devices) on its side of the Point of Interconnection, so as to reasonably minimize the likelihood of voltage and frequency abnormalities, originating in the system of one Party, from affecting or impairing the system of the other Party, or other systems to which the system of such Party is interconnected. The Parties agree that all Points of Interconnection will be established in conformance with operating guidelines of ERCOT and the ERCOT Protocols, as the same may be amended hereafter. The Parties agree to cause their systems to be constructed in accordance with specifications at least equal to those provided by the National Electrical Safety Code, approved by the American National Standards Institute, in effect at the time of construction. Except as otherwise provided in the Facility Schedules, each Party will be responsible for the equipment and facilities it owns on its side of the Point of Interconnection.

4.4 From time to time, a Point of Interconnection may be added, changed, modified, or deleted from this Agreement as mutually agreed by the Parties and/or as ordered by a regulatory authority having jurisdiction thereof. Any such change, addition, or deletion shall be recorded in Exhibit A and a Facility Schedule in such a way that the numbering of the other Facility Schedules is not changed.

4.5 Subject to regulatory approval, if required, unless mutually agreed, neither party shall have the right to disconnect from the other Party at any Point of Interconnection specified on Exhibit A and a Facility Schedule, originally attached to this Agreement or added subsequent to the execution of this Agreement, except for reason of a material violation of the terms of this Agreement, for which opportunity to correct such violation was given under Paragraph 15.1 of this Agreement and such violation was not corrected in accordance with said Paragraph 15.1.

4.6 For facilities not specified in the Facility Schedules, or if either Party makes equipment changes or additions to the equipment at a Point of Interconnection, which may affect the operation or performance of the other Party's interconnection facilities, the Parties agree to notify the other Party, in writing, of such changes. Such changes shall be made in accordance with Good Utility Practice, ERCOT requirements, the National Electrical Safety Code, other applicable codes, and standards in effect at the time of construction, and coordinated between the Parties.

4.7 Each party agrees to provide current as-built drawings to the other Party of the facilities owned by that Party at each Point of Interconnection.

4.8 The Parties agree to coordinate and cooperate on assessments of the reliability impacts to the interconnected transmission system for new facilities requesting connection to their distribution or transmission facilities, in accordance with the NERC Reliability Standards.

4.9 The City is responsible for reporting annual load data information to ERCOT as required by the ERCOT Protocols and the Parties agree to coordinate and cooperate on submitting this report

#### **ARTICLE V - OTHER SERVICES**

5.1 This Agreement is applicable only to the interconnection of the facilities of the Parties at the Points of Interconnection and does not obligate either Party to provide, or entitle either Party to receive, any service not expressly provided for herein. Each Party is responsible for making the arrangements necessary to receive any other service that either Party may desire from the other Party or any third party.

5.2 All transmission, transformation, distribution, metering, operations, and maintenance, engineering, billing or other miscellaneous services will be provided and charged under agreements separate from this Agreement.

5.3 Each Facility Schedule shall indicate whether transformation and/or metering services apply at each Point of Interconnection. Parties agree that the name and location of the Points of Interconnection in the Exhibit "A" and the Facilities Schedules attached to this Agreement, will be identical to the name used and the location of the corresponding facilities in the Transformation Service Agreement.

#### **ARTICLE VI - SYSTEM OPERATION AND MAINTENANCE**

6.1 Unless otherwise provided by the Facility Schedules, each Party shall, at each Point of Interconnection, at its own risk and expense, operate and maintain the facilities (including all apparatus and necessary protective devices) it owns or hereafter may own, so as to reasonably minimize the likelihood of voltage and frequency abnormalities, originating in the system of one Party, from affecting or impairing the system of the other Party, or other systems to which the Party is interconnected. The Parties agree that all Points of Interconnection will be operated and maintained in conformance with operating guidelines of ERCOT and the ERCOT Protocols, as the same may be amended hereafter.

6.2 Operational responsibility for facilities owned by one Party, but installed in another Party's substation or transmission line will be identified in the Facility Schedule for that particular Point of Interconnection.

6.3 During the term of this Agreement, the Parties will, consistent with maintaining good operating practices, coordinate their operations to maintain continuity of services to their respective customers to the extent practicable. Planned facility maintenance by either Party that will cause a deviation from the normal power and energy flow at a Point of Interconnection will be scheduled at a mutually agreeable time. No changes will be made in the normal operation of a Point of Interconnection without the mutual agreement of the Parties. The Parties will, to the extent necessary to support continuity of operations, coordinate the operation of protective devices on the facilities they operate in the proximity of the Points of Interconnection which might reasonably be expected to affect the operation of facilities on the other Party's system.

6.4 Each Party will provide the reactive requirements for its own system in accordance with the operating guides as established from time to time by ERCOT or its successor. Each Party will provide the reactive requirements for its own system so as not to impose a burden on the other system.

6.5 The City designates LCRA TSC to perform the functions of an "ERCOT Transmission Operator" on the City's behalf as described in the ERCOT Protocols. As the ERCOT Transmission Operator acting on behalf of the City, LCRA TSC shall have full authority to perform any necessary load shedding, switching, and other transmission activities that are deemed necessary to reliably maintain the electric system.

6.6 The City shall ensure that its operators designated to carry out dispatch instructions from LCRA TSC are properly authorized and trained to comply with all reliability directives issued by LCRA TSC, including shedding firm load, unless such actions would violate



safety, equipment, regulatory or statutory requirements. Under these circumstances, the City's operators shall immediately inform LCRA TSC of the inability to perform the directive so that LCRA TSC can implement alternate remedial actions.

6.7 During periods of emergency conditions declared by the ERCOT Independent System Operator, or its successor, or as necessary to restore customer service, either Party may operate equipment that is normally operated by the other Party, provided that authorization to do so must first be received from the Party that normally operates the equipment, such authorization not to be unreasonably withheld or delayed. It shall be considered reasonable for the Party that normally operates such equipment to deny such a request by the other Party if the withholding Party will provide such operation within the time frame called for in the circumstances. Such operations by the other Party will be at no cost to the owner or normal operator of the equipment.

6.8 Each Party will determine the operating limits of the facilities that it owns and make such limits known to the Party operating those facilities. The operating Party of those facilities will not exceed those limits without prior approval of the Party owning the facilities.

6.9 The City's requirement for under-frequency relaying, as described in the ERCOT Protocols, is accomplished through its participation within the LCRA TSC under-frequency load shed (UFLS) program, however, each Party that owns UFLS equipment must individually comply with ERCOT requirements and NERC Reliability Standards pertaining to UFLS equipment ownership, including but not limited to relay testing and maintenance documentation.

## **ARTICLE VII - RIGHTS OF ACCESS, EQUIPMENT INSTALLATION, AND REMOVAL**

7.1 Each Party shall permit duly authorized representatives and employees of the other Party to enter upon its premises for the purpose of inspecting, testing, repairing, renewing, or exchanging any or all of the equipment owned by such other Party that is located on such premises or for the purpose of performing any work necessary in the performance of this Agreement.

7.2 Each Party grants to the other Party permission to install, maintain, and/or operate, or cause to be installed, maintained, and/or operated, on its premises, the necessary equipment, apparatus, and devices required for the performance of this Agreement. Any such installation, maintenance, and operation to be performed, except in the case of emergencies, shall be performed only after a schedule of such activity has been submitted and agreed upon by the Parties.

7.3 Any and all equipment, apparatus, and devices placed or installed, or caused to be placed or installed by one Party on, or in, the premises of the other Party, shall be and remain the property of the Party owning and installing such equipment, apparatus, devices, or facilities, regardless of the mode and manner of annexation or attachment to real property. Upon the termination of any Point of Interconnection under this Agreement, the Party owning and installing such equipment, apparatus, devices, or facilities on the property of the other Party, shall 1) have the right to sell such equipment, apparatus, devices, or facilities to the other Party if the other Party

wishes to purchase such equipment, apparatus, devices, or facilities or 2) to enter the premises of the other Party and, within a reasonable time, remove such equipment, apparatus, devices, or facilities, at no cost to the owner of the premises. If, upon the termination of any Point of Interconnection under this Agreement, equipment of a Party that is installed on the premises of the other Party is either not sold to the other Party or removed by the owning Party within a reasonable time, it shall be considered abandoned by the owning Party and may be disposed of by the other Party in the manner it shall determine appropriate; provided, however, that any net cost incurred by the disposing Party shall be reimbursed by the abandoning party.

7.4 Each Party shall clearly mark their respective equipment, apparatus, devices, or facilities with appropriate ownership identification.

7.5 Either Party may request the other Party to upgrade or modify its terminal facilities at a Point of Interconnection in accordance with the other Party's standard design of equipment. Such request shall not be unreasonably denied.

#### **ARTICLE VIII – METERING AND RECORDS**

8.1 All metering equipment required herein shall be selected, installed, tested, operated, and maintained by the Party owning such metering equipment in accordance with Good Utility Practice, applicable ERCOT operating and metering guidelines, and the ERCOT Protocols.

8.2 The Party that does not own the metering equipment shall be permitted to witness any testing, inspection, maintenance, or alteration of such metering equipment owned by the other Party. The owner of such equipment shall give reasonable advance notice of all tests and inspections so that representatives of the other Party may be present. After proper notification to the other Party, the owner may proceed with the scheduled tests or inspections regardless of whether a witness is present.

8.3 If any test or inspection of metering equipment shows that it does not meet the accuracy requirements established by ERCOT operating or metering guidelines, whichever is applicable, the meter or other equipment found to be inaccurate or defective shall be promptly repaired, adjusted, or replaced by the owner. Should metering equipment fail to register, the power and energy delivered and received shall be determined in accordance with ERCOT operating or metering guidelines, and ERCOT Protocols.

#### **ARTICLE IX – COMMUNICATION AND TELEMETERING FACILITIES**

9.1 Each Party shall provide, at its own expense, the necessary communication and telemetering facilities needed for the control and operation of its transmission and/or distribution system.

9.2 All communication and telemetering facilities required herein shall be selected, installed, tested, operated, and maintained by the Party owning such equipment in accordance with

Good Utility Practice, applicable ERCOT operating and metering guidelines, and the ERCOT Protocols.

9.3 The City's requirement (if any) to supply real-time telemetry data to ERCOT, as described in the ERCOT Protocols and referred to in the NERC Reliability Standards, is accomplished through the LCRA TSC as it performs the functions of the City's ERCOT Transmission Operator.

#### **ARTICLE X - INDEMNIFICATION**

10.1 EACH PARTY SHALL INDEMNIFY, DEFEND, AND SAVE HARMLESS THE OTHER PARTY, ITS DIRECTORS, OFFICERS, AND AGENTS (INCLUDING, BUT NOT LIMITED TO, DIRECTORS, OFFICERS, AND EMPLOYEES OF ITS AFFILIATES AND CONTRACTORS) FROM ANY AND ALL DAMAGES, LOSSES, CLAIMS, INCLUDING CLAIMS AND ACTIONS RELATING TO INJURY TO OR DEATH OF ANY PERSON OR DAMAGE TO PROPERTY, DEMANDS, SUITS, RECOVERIES, COSTS AND EXPENSES, COURT COSTS, ATTORNEY FEES, AND ALL OTHER OBLIGATIONS BY OR TO THIRD PARTIES, ARISING OUT OF OR RESULTING FROM GROSS NEGLIGENCE OR OTHER FAULT IN THE DESIGN, CONSTRUCTION, OR OPERATION OF THEIR RESPECTIVE FACILITIES DURING THE PERFORMANCE OF THIS AGREEMENT AND TO THE EXTENT PERMITTED BY LAW, EXCEPT IN CASES OF GROSS NEGLIGENCE OR INTENTIONAL WRONGDOING BY THE OTHER PARTY.

#### **ARTICLE XI -NOTICES**

11.1 Notices of an administrative nature, including but not limited to a notice of termination, a request for amendment, a change to a Point of Interconnection, or a request for a new Point of Interconnection, shall be forwarded to the designees listed below for each Party and shall be deemed properly given if delivered in writing to the following:

- (a) San Marcos Electric Utility  
Electric Utility Director  
630 East Hopkins  
San Marcos, TX. 78666-6397
  
- (b) LCRA TRANSMISSION SERVICES CORPORATION  
Manager, Transmission Engineering  
LCRA  
P.O. Box 220  
Austin, TX 78767-0220

11.2 The above listed names, titles, and addresses of either Party may be changed upon written notification to the other Party.

## **ARTICLE XII - SUCCESSORS AND ASSIGNS**

12.1 Subject to the provisions of Section 12.2 below, this Agreement shall be binding upon and inure to the benefit of the permitted successors and assigns of the respective Parties.

12.2 Neither Party shall assign its interest in this Agreement in whole or in part without the prior written consent of the other Party. Such consent shall not be unreasonably withheld, provided that neither Party will be required to consent to any assignment which would, in its sole judgment and among other reasons, subject it to additional federal or state regulation, result in the imposition of additional costs of administration which the Party requesting assignments does not agree to reimburse, or in any way diminish the reliability of its system, enlarge its obligations or otherwise create or maintain an unacceptable condition. The respective obligations of the Parties under this Agreement may not be changed, modified, amended, or enlarged, in whole or in part, by reason of the sale, merger, or other business combination of either Party with any other person or entity. Notwithstanding the foregoing, a Party may assign, without the consent of the other Party, its interest in this Agreement, in whole or in part (1) to a successor that has an interest to all or a substantial portion of the Party's transmission and distribution business; or (2) in connection with any financing or financial arrangements.

12.3 The several provisions of this Agreement are not intended to and shall not create rights of any character whatsoever in favor of any persons, corporations, or associations other than the Parties to this Agreement, and the obligations herein assumed are solely for the use and benefit of the Parties to this Agreement.

## **ARTICLE XIII – GOVERNING LAW AND REGULATION**

13.1 This Agreement was executed in the State of Texas and must in all respects be governed by, interpreted, construed, and enforced in accordance with the laws thereof except as to matters exclusively controlled by the Constitution and statutes of the United States of America. This Agreement is subject to all valid applicable federal, state, and local laws, ordinances, rules, and regulations of duly constituted regulatory authorities having jurisdiction.

13.2 This Agreement and all obligations hereunder, are expressly conditioned upon obtaining approval or authorization or acceptance for filing by any regulatory body, whose approval, authorization or acceptance for filing is required by law. Both Parties hereby agree to support the approval of this Agreement before such regulatory authority and to provide such documents, information, and opinions as may be reasonably required or requested by either Party in the course of approval proceedings.

13.3 In the event that a regulatory authority having jurisdiction over the Parties orders a change in the terms of this Agreement, the Parties agree to negotiate in good faith a replacement term that will most nearly accomplish the purpose and intent of the original term consistent with the

regulatory order. If the Parties cannot reach an agreement over the new term, and if the old term is an essential provision of this Agreement, either Party may elect to terminate this Agreement, by providing notice of such election to the other upon sixty (60) days prior written notice to the other Party. An election to terminate under this provision shall not affect either Party's duty to perform prior to the effective date of termination.

13.4 In the event any part of this Agreement is declared invalid by a court of competent jurisdiction, the remainder of said Agreement shall remain in full force and effect and shall constitute a binding agreement between the Parties provided, however, that if either Party determines, in its sole discretion, that there is a material change in this Agreement by reason of any provision or application being finally determined to be invalid, illegal, or unenforceable, that Party may terminate this Agreement upon sixty (60) days prior written notice to the other Party. An election to terminate under this provision shall not affect either Party's duty to perform prior to the effective date of termination.

#### **ARTICLE XIV – DEFAULT AND FORCE MAJEURE**

14.1 Neither Party shall be considered in default with respect to any obligation hereunder, other than the payment of money, if prevented from fulfilling such obligations by reason of any cause beyond its reasonable control, including, but not limited to, outages or interruptions due to weather, accidents, equipment failures or threat of failure, strikes, civil unrest, injunctions, or order of governmental authority having jurisdiction. If performance by either Party has been prevented by such event, the affected Party shall promptly and diligently attempt to remove the cause of its failure to perform, except that neither Party shall be obligated to agree to any quick settlement of any strike or labor disturbance, which, in the affected Party's opinion, may be inadvisable or detrimental, or to appeal from any administrative or judicial ruling.

#### **ARTICLE XV - TERMINATION ON DEFAULT**

15.1 Should either of the Parties hereto violate any material provisions of this Agreement, the other Party shall give written notice to the violating Party specifying the violation. Upon actual receipt of such notice, the Party shall have one hundred eighty (180) days to correct such violation. In the event such violation of this Agreement is not corrected by the expiration of said one hundred eighty (180) days, this Agreement, subject to the applicable regulations of any jurisdictional regulatory authority, may be terminated by giving no less than sixty (60) days written notice, but no other remedy or remedies, available under the law, for such violation shall be limited in any way because of this provision or the exercise of the right conferred hereunder.

15.2 The failure of a Party to this Agreement to insist, on any occasion, upon strict performance of this Agreement will not be considered to waive the obligations, rights, or duties imposed upon the Parties by this Agreement.

## ARTICLE XVI- MISCELLANEOUS PROVISIONS

16.1 Any undertaking by a Party to the other Party under this Agreement shall not constitute the dedication of the electrical system or any portion thereof of that Party to the public or to the other Party, and it is understood and agreed that any such undertaking shall cease upon the termination of this Agreement.

16.2 The several provisions of this Agreement are not intended to and shall not create rights of any character in, nor be enforceable by, parties other than the signatories to this Agreement and their assigns.

16.3 Neither Party shall be liable to the other for any indirect, consequential, incidental, punitive, or exemplary damages.

16.4 This Agreement shall not affect the obligations or rights of either Party with respect to other agreements. Both Parties to this Agreement represent that there is no agreement or other obligation binding upon it, which, as such Party is presently aware, would limit the effectiveness or frustrate the purpose of this Agreement.

16.5 This Agreement may be amended only upon mutual agreement of the Parties, such amendment will not be effective until reduced in writing and executed by the Parties.

16.6 The descriptive headings of the various sections of this Agreement have been inserted for convenience of reference only and are to be afforded no significance in the interpretation or construction of this Agreement.

16.7 The invalidity of one or more phrases, sentences, clauses, Sections or Articles contained in this Agreement shall not affect the validity of the remaining portions of this Agreement so long as the material purposes of this Agreement can be determined and carried out.

16.8 This Agreement will be executed in two or more counterparts, each of which is deemed an original, but all constitute one and the same instrument.

IN WITNESS WHEREOF, the Parties have caused this Interconnection Agreement between LCRA Transmission Services Corporation and San Marcos Electric Utility, Texas to be executed in two (2) counterparts, each of which shall constitute an original, on the day and year first written above.

**SAN MARCOS ELECTRIC UTILITY**

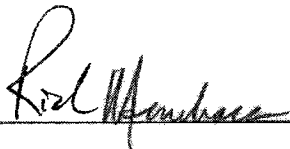
By: 

Title: City Manager

Date: 4/14/09

**LCRA TRANSMISSION SERVICES CORPORATION**

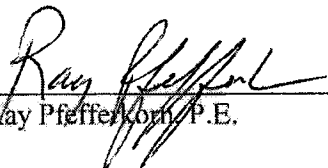
By:   
Ray Pfefferkorn, P.E.

Title: LCRA Transmission Engineering Manager

Date: 5/26/09







## FACILITY SCHEDULE NO. 1

1. **Name:** Hilltop Substation
2. **Facility Location:** The Hilltop Substation is located at 321 Lamar Ave., San Marcos, Hays County, Texas.
3. **Points of Interconnection:** There are four (4) Points of Interconnection in the Hilltop Substation generally described as:
  - where the jumper from switch 9539 connects to the 138kV bus at breaker 9540.
  - where the jumper from switch 9543 connects to the 138kV bus at breaker 9540.
  - where the jumper from switch 9549 connects to the 138kV bus at breaker 9550.
  - where the jumper from switch 9553 connects to the 138kV bus at breaker 9550.
4. **Transformation Services Provided by LCRA TSC:** No
5. **Metering Services Provided by LCRA TSC:** Yes
6. **Delivery Voltage:** 138 kV
7. **Metered Voltage and Location:** The metered voltage is 12.5 kV. The metering current transformers are located in bay 2 and bay 4 of the distribution system. The metering potential transformers are located on the 12.5 kV operating bus.
8. **One Line Diagram Attached:** Yes
9. **Description of Facilities Owned by Each Party:**

San Marcos Electric Utilities owns:

  - The site (property), including site work, fence, foundations, and ground grid
  - One (1) power transformer PWT-1, T-1 with associated surge arresters, and protective relaying
  - One (1) circuit switcher CS-2555 with 138 kV disconnect switch 2554
  - 138 kV bus with associated steel supporting structures and insulators
  - Four (4) distribution circuit breakers HI-10, HI-30, HI-40, HI-50
  - 12.5 kV steel structures, switches, insulators, bus, fused cutouts, and distribution class surge arresters
  - Station Service equipment
  - Control house with station battery

LCRA TSC owns:

- Two (2) 138 kV circuit breakers 9540, 9550 with foundations and protective relaying along with line, bus, and by-pass switches numbers: 9539, 9541, 9543, 9549, 9551, and 9553
- Two (2) 138 kV dead-end towers with associated bus, insulators, and surge arresters
- Underfrequency relay panel
- 12.5 kV metering potential transformers
- 138 kV bus potential transformers with 138 kV motor operated switch 9538
- 12.5 kV metering current transformers CT-1 and CT-3
- 138 kV relaying current transformer CT-4
- Panel 7, 138kV bus differential and breaker failure control circuits.

10. **Operational Responsibilities of Each Party:** Each Party will be responsible for the operation of the equipment it owns.
11. **Maintenance Responsibilities of Each Party:** Each Party will be fully responsible for the maintenance of the equipment it owns.
12. **Other Terms and Conditions:** The City and LCRA TSC are to share access to the substation by LCRA TSC locks in the gate and in the control house doors.

# HILLTOP ONE-LINE DIAGRAM

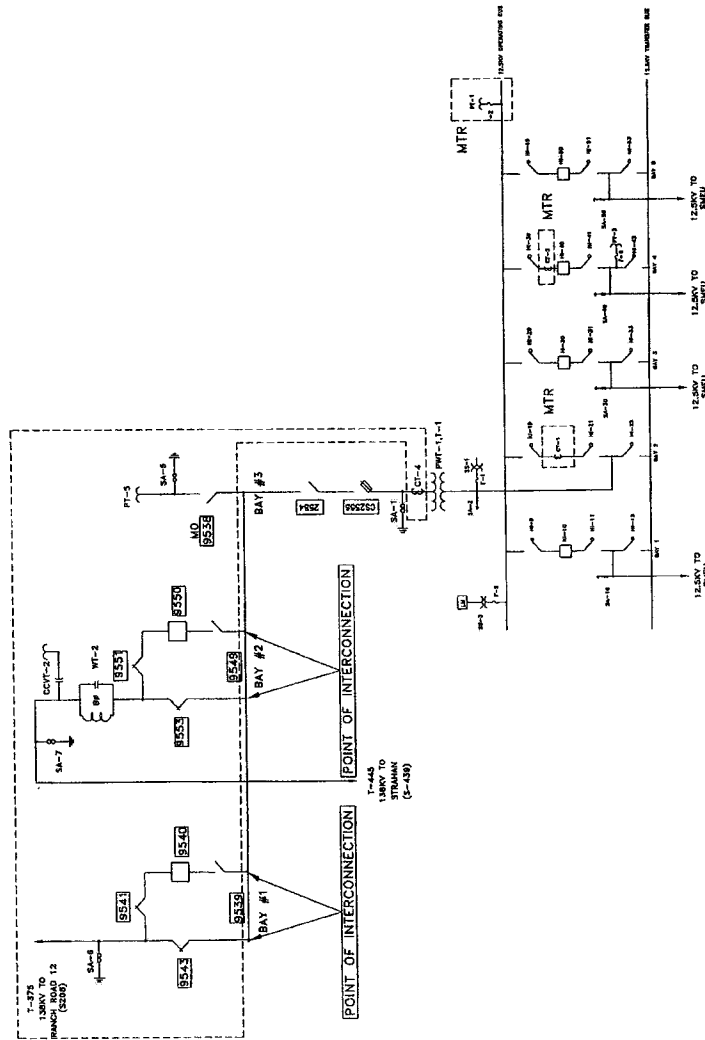

HILLTOP SUBSTATION  
 THIS IS NOT A COMPLETE ONE-LINE DIAGRAM  
 FOR A COMPLETE ONE-LINE DIAGRAM OF THIS  
 SUBSTATION, REFER TO DWG. S236-E-2.

## FACILITY SCHEDULE NO. 2

1. **Name:** Strahan Substation
2. **Facility Location:** The Loop 82/Strahan Substation is located at 709 Aquarena Springs Dr. (Loop 82), San Marcos, Hays County, Texas.
3. **Point of Interconnection:** There is one (1) Point of Interconnection in the Strahan Substation: where the 12.5 kV bus terminates at the power transformer PWT-1 LV bushings.
4. **Transformation Services Provided by LCRA TSC:** Yes
5. **Metering Services Provided by LCRA TSC:** Yes
6. **Delivery Voltage:** 12.5 kV
7. **Metered Voltage and Location:** The metered voltage is 12.5 kV. The metering current transformers are located in PWT-1. The metering potential transformers are located on the 12.5 kV operating bus.
8. **One Line/Diagram Attached:** Yes
9. **Description of Facilities Owned by Each Party:**

San Marcos Electric Utilities owns:

- The site (property), including site work, fence, foundations, and ground grid
- Five (5) distribution circuit breakers ST-510, ST-520, ST-530, ST-550, ST-560
- 15 kV (60:1 ratio) bus potential transformers
- Six (6) distribution and total bays including A-frames, trusses, insulators, disconnect switches, surge arresters, 12.5 kV operating and transfer bus, bus potential transformers and metering current transformers
- Control house with station battery

LCRA TSC owns:

The 138 kV portion of the substation, including, but not limited to, the following items:

- One (1) power transformer PWT-1, T-1 with associated surge arresters
- One (1) 138 kV circuit switcher CS-9515 with bypass switch 9517 and disconnect switch 9512
- Station Service equipment

10. **Operational Responsibilities of Each Party:** Each Party will be responsible for the operation of the equipment it owns.
11. **Maintenance Responsibilities of Each Party:** Each Party will be fully responsible for the

maintenance of the equipment it owns.

12. **Other Terms and Conditions:** The City and LCRA TSC are to share access to the substation by LCRA TSC locks in the gate and in the control house doors.

# STRAHAN ONE-LINE DIAGRAM

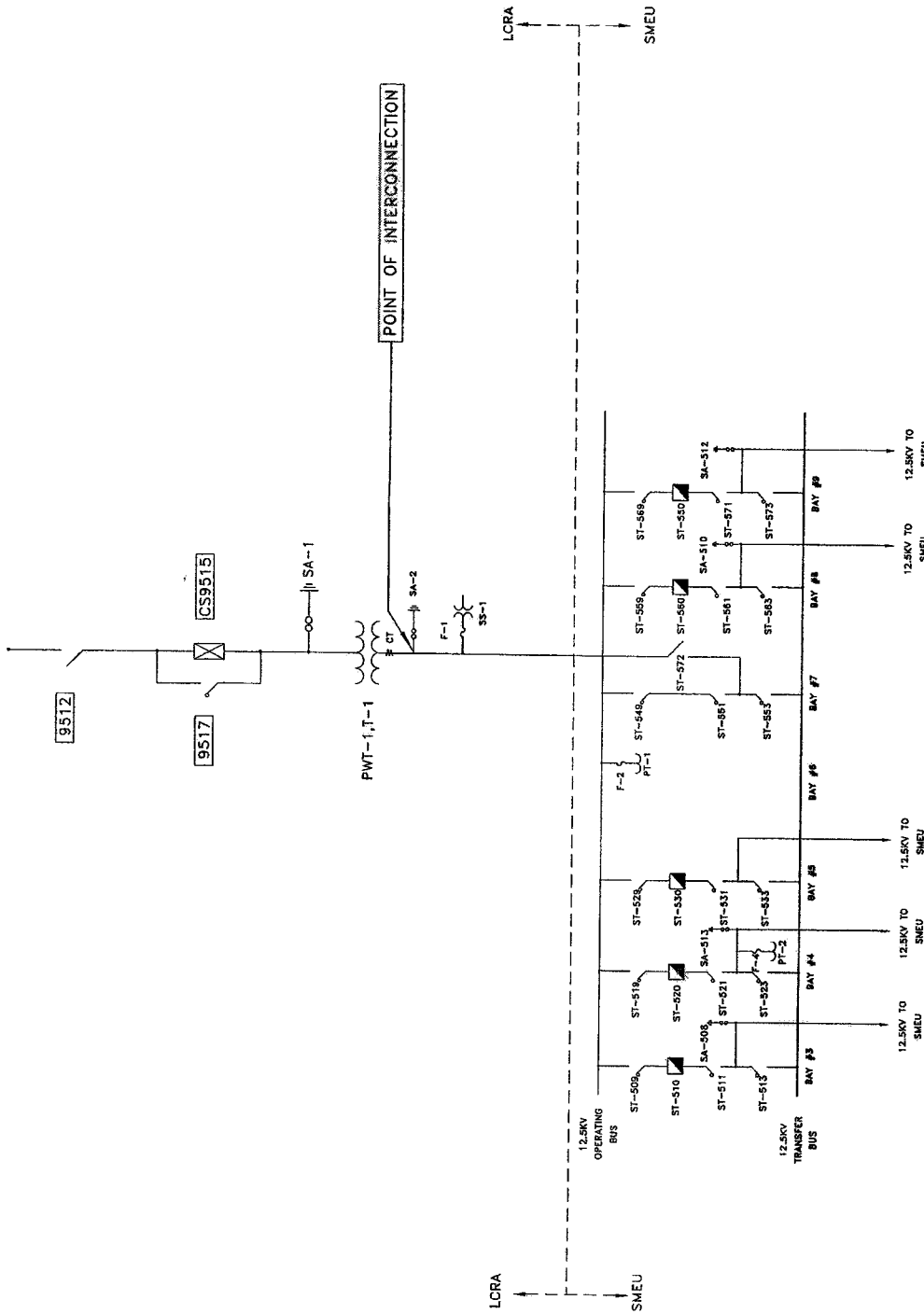

STRAHAN SUBSTATION  
 THIS IS NOT A COMPLETE ONE-LINE DIAGRAM  
 FOR A COMPLETE ONE-LINE DIAGRAM OF THIS  
 SUBSTATION, REFER TO DRAWING S439-E-0003.

### FACILITY SCHEDULE NO. 3

1. **Name:** McCarty Lane Substation
2. **Facility Location:** The McCarty Lane Substation is located at 1502 E. McCarty Lane, San Marcos, Hays County, Texas.
3. **Points of Interconnection:** There are six (6) points of interconnection at McCarty Lane Substation generally described as:
  - where the incoming distribution line connects to the tubular bus between switches ML-31 and ML-33 at breaker ML-30.
  - where the jumper from breaker ML-30, passing through CT-5, connects to the 4 hole pad on switch ML-29.
  - where the jumper from breaker ML-30 connects to the 4 hole pad on switch ML-31.
  - where the incoming distribution line connects to the tubular bus between switches ML-41 and ML-43 at breaker ML-40.
  - where the jumper from breaker ML-40, passing through CT-6 connects to the 4 hole pad on switch ML-39.
  - where the jumper from breaker ML-40 connects to the 4 hole pad on switch ML-41.
4. **Transformation Services Provided by LCRA TSC:** Yes
5. **Metering Services Provided by LCRA TSC:** Yes
6. **Delivery Voltage:** 12.5 kV
7. **Metered Voltage and Location:** The metered voltage is 12.5 kV. The metering current transformers are located in the distribution bays ML-30 and ML-40. The metering potential transformers are located on the 12.5 kV operating bus.
8. **One Line Diagram Attached:** Yes
9. **Description of Facilities Owned by Each Party:**

San Marcos Electric Utilities owns:

  - Two (2) distribution circuit breakers ML-30 and ML-40, and associated foundations, jumpers, relaying, control panels, and cabling
  - Six (6) riser pole distribution surge arresters at the feeder exits
  - Two (2) steel distribution structures for underground feeder exits

LCRA TSC owns:

McCarty Lane Substation including, but not limited to, the following items:

- 138 kV bus, switches, and structures for transformer PWT-1
- One (1) 138 kV circuit switcher CS-9655 with bypass switch 9657 and disconnect switch 9654
- One (1) power transformer PWT-1, T-1 with associated surge arresters
- Three (3) distribution and total bays including A-frames, trusses, insulators, disconnect switches, 12.5 kV operating and transfer bus, bus potential transformers and metering current transformers
- Station Service equipment
- Control house with station battery

10. **Operational Responsibilities of Each Party:** Each Party will be responsible for the operation of the equipment it owns.
11. **Maintenance Responsibilities of Each Party:** Each Party will be fully responsible for the maintenance of the equipment it owns.
12. **Other Terms and Conditions:** The City and LCRA TSC are to share access to the substation by LCRA TSC locks in the gate and in the control house doors.



# MCCARTY LANE ONE-LINE DIAGRAM

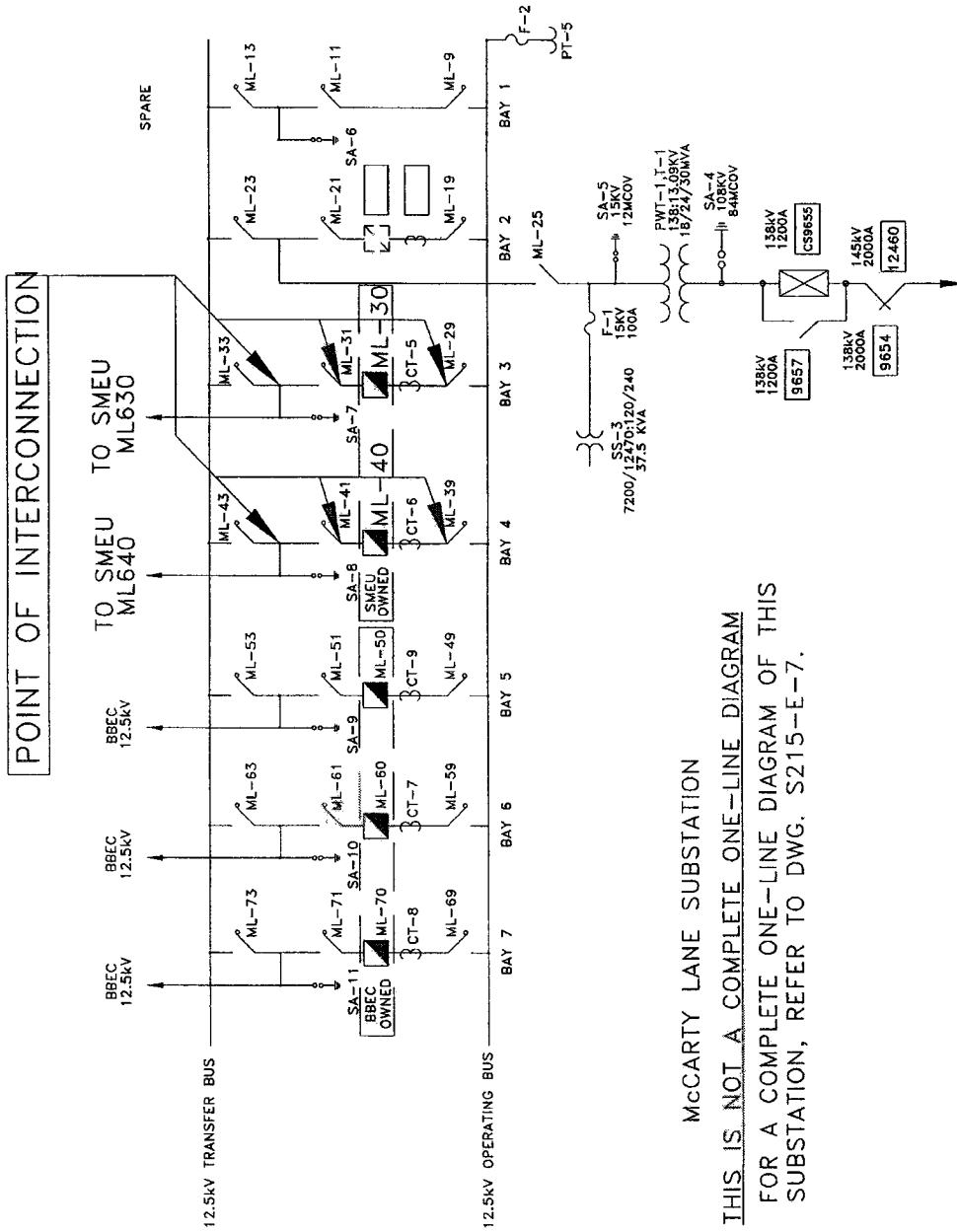

MCCARTY LANE SUBSTATION  
 THIS IS NOT A COMPLETE ONE-LINE DIAGRAM  
 FOR A COMPLETE ONE-LINE DIAGRAM OF THIS  
 SUBSTATION, REFER TO DWG. S215-E-7.

24

## FACILITY SCHEDULE NO. 4

1. **Name:** Ranch Road 12 Substation
2. **Facility Location:** The Ranch Road 12 Substation is located at 2701 RR 12, San Marcos, Hays County, Texas.
3. **Point of Interconnection:** There is one (1) point of interconnection at Ranch Road 12 Substation: generally described as where the jumper from the McCarty Lane/Hilltop 138 kV string bus connects to the 138 kV tubular bus.
4. **Transformation Services Provided by LCRA TSC:** No
5. **Metering Services Provided by LCRA TSC:** Yes
6. **Delivery Voltage:** 138 kV
7. **Metered Voltage and Location:** The metered voltage is 12.5 kV. The metering current transformers are located in each distribution bay. The metering potential transformers are located on the 12.5 kV operating bus.
8. **One Line Diagram Attached:** Yes
9. **Description of Facilities Owned by Each Party:**

San Marcos Electric Utility owns:

- The site (property), including site work, fence, foundations, and ground grid
- One (1) power transformer PWT-1, T-1 with associated surge arresters, and protective relaying
- One (1) circuit switcher CS-3955
- 138 kV transformer bus with associated steel structures, surge arresters, and insulators
- Three (3) distribution bays including A-frames, trusses, insulators, disconnect switches, surge arresters, 12.5 kV operating and transfer bus
- Three (3) distribution circuit breakers RR-30, RR-40, RR-60
- Station Service equipment
- Control house with station battery

LCRA TSC owns:

- Two (2) 138 kV line interrupting motor operated switches MO-3969 and MO-3959
- Two (2) 138 kV dead-end towers with associated main bus and insulators
- 12.5 kV bus potential transformers
- Underfrequency relay panel

- 12.5 kV metering current transformers CT-1, CT-3, CT-4
10. **Operational Responsibilities of Each Party:** Each Party will be responsible for the operation of the equipment it owns.
  11. **Maintenance Responsibilities of Each Party:** Each Party will be fully responsible for the maintenance of the equipment it owns.
  12. **Other Terms and Conditions:** The City and LCRA TSC are to share access to the substation by LCRA TSC locks in the gate and in the control house doors.

# RANCH ROAD 12 ONE-LINE DIAGRAM

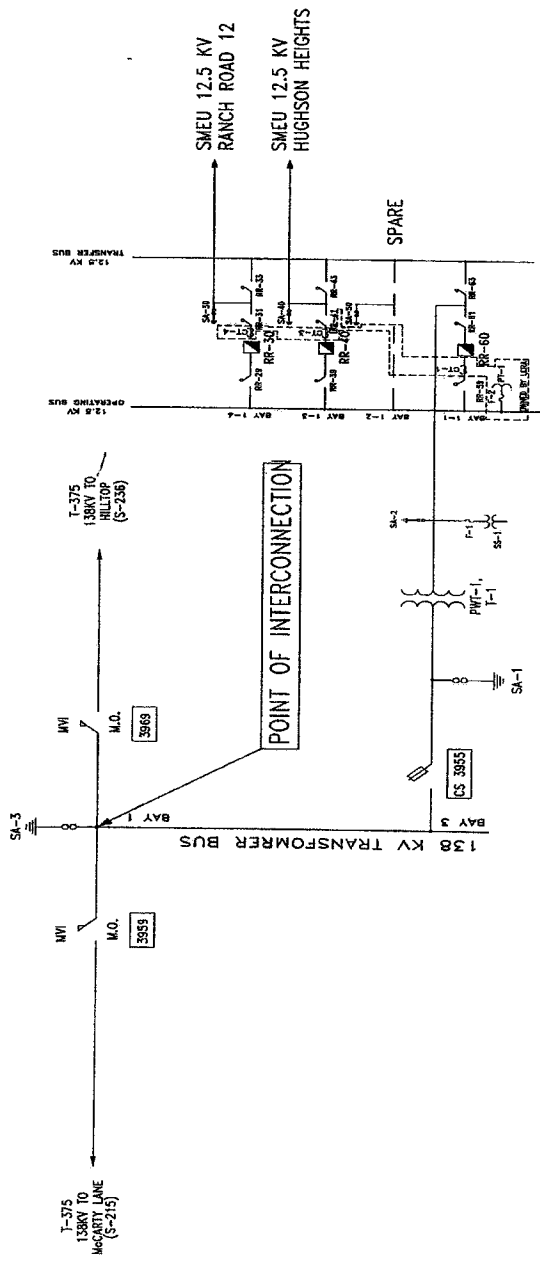

THIS IS NOT A COMPLETE ONE-LINE DIAGRAM

FOR A COMPLETE ONE-LINE DIAGRAM OF THIS  
SUBSTATION, REFER TO DWG. S208-E-2.

## FACILITY SCHEDULE NO. 5

1. **Name:** Redwood Substation
2. **Facility Location:** The Redwood Substation is located at 1375 Wonder World Drive, San Marcos, Hays County, Texas.
3. **Points of Interconnection:** There are a total of twelve (12) points of interconnection at Redwood Substation generally described as:
  - where the 138 kV transformer bus connects to Operating Bus #1 for PWT-2.
  - where the 138 kV transformer bus connects to Operating Bus #2 for PWT-2.
  - where the incoming distribution line connects to the tubular bus between switches RW-321 and RW-323 at breaker RW-320.
  - where the jumper from breaker RW-320, passing through CT-15, connects to the 4 hole pad on switch RW-319.
  - where the jumper from breaker RW-320 connects to the 4 hole pad on switch RW-321.
  - where the incoming distribution line connects to the tubular bus between switches RW-341 and RW-343 at breaker RW-340.
  - where the jumper from breaker RW-340, passing through CT-11, connects to the 4 hole pad on switch RW-339.
  - where the jumper from breaker RW-340 connects to the 4 hole pad on switch RW-341.
  - where the jumper from switch RW-202 connects to the 12.5 kV Operating bus for PWT-2, T-2.
  - where the jumper from switch RW-205 connects to the 12.5 kV Transfer bus for PWT-2, T-2.
  - where the jumper from switch RW-102 connects to the 12.5 kV Operating bus for PWT-2, T-2.
  - where the jumper from switch RW-105 connects to the 12.5 kV Transfer bus for PWT-2, T-2.
4. **Transformation Services Provided by LCRA TSC:** Yes
5. **Metering Services Provided by LCRA TSC:** Yes
6. **Delivery Voltage:** 138 kV for PWT-2; 12.5 kV for PWT-3
7. **Metered Voltage and Location:** The metered voltage is 12.5 kV. The metering current transformers are located in each individual bay. The metering potential transformers are located on the 12.5 kV operating buses.
8. **One Line Diagram Attached:** Yes

**9. Description of Facilities Owned by Each Party:**

San Marcos Electric Utility owns:

- One (1) power transformer PWT-2, T-2 with associated foundation, surge arresters, and protective relaying
- One (1) circuit switcher CS-8235 with bypass switch 8236. 138 kV transformer bus with associated steel structures for PWT-2, 138 kV operating bus disconnect switches 8237 and 8238, and insulators
- Three (3) distribution bays including A-frames, trusses, insulators, disconnect switches, surge arresters, 12.5 kV operating and transfer bus, and metering current transformers for PWT-2, T-2
- Five (5) distribution circuit breakers RW-220, RW-230, RW-240, RW-320, RW-340
- Disconnect switches in distribution bays 1-0 and 1-4

LCRA TSC owns:

The Redwood Substation including, but not limited to, the following items:

- One (1) 138 kV circuit switcher CS-19235 with bypass switch 19232 and disconnect switches 19237 and 19238
- One (1) power transformer PWT-3, T-3 with associated surge arresters
- Three (3) distribution and total bays including A-frames, trusses, insulators, disconnect switches, surge arresters, 12.5 kV operating and transfer bus, bus potential transformers and metering current transformers for PWT-3, T-3
- One (1) total circuit breaker RW-330
- Station Service equipment for PWT-3
- 12.5 kV bus potential transformers for PWT-2, and PWT-3, and metering current transformers
- Control house with station battery

- 10. Operational Responsibilities of Each Party:** Each Party will be responsible for the operation of the equipment it owns.
- 11. Maintenance Responsibilities of Each Party:** Each Party will be fully responsible for the maintenance of the equipment it owns.
- 12. Other Terms and Conditions:** The City and LCRA TSC are to share access to the substation by LCRA TSC locks in the gate and in the control house doors.

# REDWOOD ONE-LINE DIAGRAM

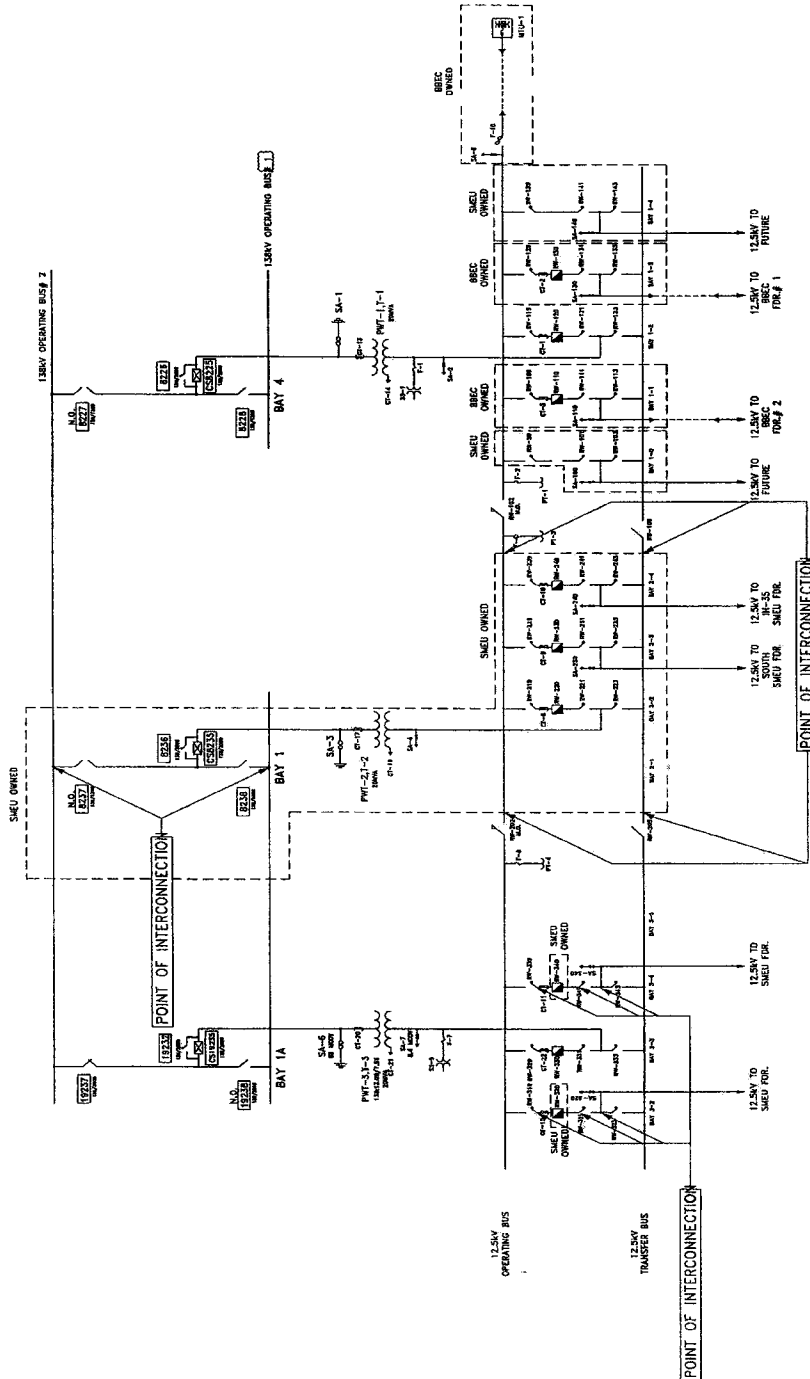

REDWOOD SUBSTATION

THIS IS NOT A COMPLETE ONE-LINE DIAGRAM

FOR A COMPLETE ONE-LINE DIAGRAM OF THIS  
SUBSTATION, REFER TO DWG. S2226-E-2.

## FACILITY SCHEDULE NO. 6

1. **Name:** San Marcos Substation
2. **Facility Location:** The San Marcos Substation is located at 1301 River Road, San Marcos, Hays County, Texas.
3. **Points of Interconnection:** There are four (4) points of interconnection at San Marcos Substation generally described as:
  - where the jumper from switch 3942 on the transformer bus for power transformer PWT-1 connects to the 138 kV main bus.
  - where the jumper from switch 3944 on the transformer bus for power transformer PWT-1 connects to the 138 kV transfer bus.
  - where the jumper from switch 4986 on the transformer bus for power transformer PWT-2 connects to the 138 kV main bus.
  - where the jumper from switch 4987 on the transformer bus for power transformer PWT-2 connects to the 138 kV transfer bus.
4. **Transformation Services Provided by LCRA TSC:** No
5. **Metering Services Provided by LCRA TSC:** Yes
6. **Delivery Voltage:** 138 kV
7. **Metered Voltage and Location:** The metered voltage is 12.5 kV. The metering current transformers are located in the 12.5 kV total bays for the two power transformers (PWT-1 and PWT-2). The metering potential transformers are located on the respective 12.5 kV operating buses.
8. **One Line Diagram Attached:** Yes
9. **Description of Facilities Owned by Each Party:**

San Marcos Electric Utilities owns:

  - The site (property), including site work, fence, foundations, and ground grid
  - Two (2) transformers PWT-1, T-1 and PWT-2, T-2
  - Two (2) circuit switchers CS-4975 and CS-4985 and 138 kV disconnect switches 4974, 3942, 3944, 4984, 4986 and 4987.
  - 138 kV transformer bus with associated steel structures and insulators
  - Six (6) distribution circuit breakers SM-160, SM-170, SM-180, SM-220, SM-230, SM-240
  - Two (2) total circuit breakers SM-100 and SM-200



- Eight (8) distribution and total bays including A-frames, trusses, insulators, disconnect switches, surge arresters, 12.5 kV operating and transfer bus, bus potential transformers and metering current transformers
- Metering current transformers CT-2 and CT-3

LCRA TSC owns:

- 138 kV operating and transfer bus
- 12.5 kV and 138 kV bus potential transformers
- Four (4) Relaying current transformers CT-7, CT-8, CT-9 and CT-10
- Underfrequency relay panel
- Control house and station battery
- Station Service equipment

- 10. Operational Responsibilities of Each Party:** Each Party will be responsible for the operation of the equipment it owns.
- 11. Maintenance Responsibilities of Each Party:** Each Party will be fully responsible for the maintenance of the equipment it owns.
- 12. Other Terms and Conditions:** The City and LCRA TSC are to share access to the substation by LCRA TSC locks in the gate and in the control house doors.

# SAN MARCOS ONE-LINE DIAGRAM

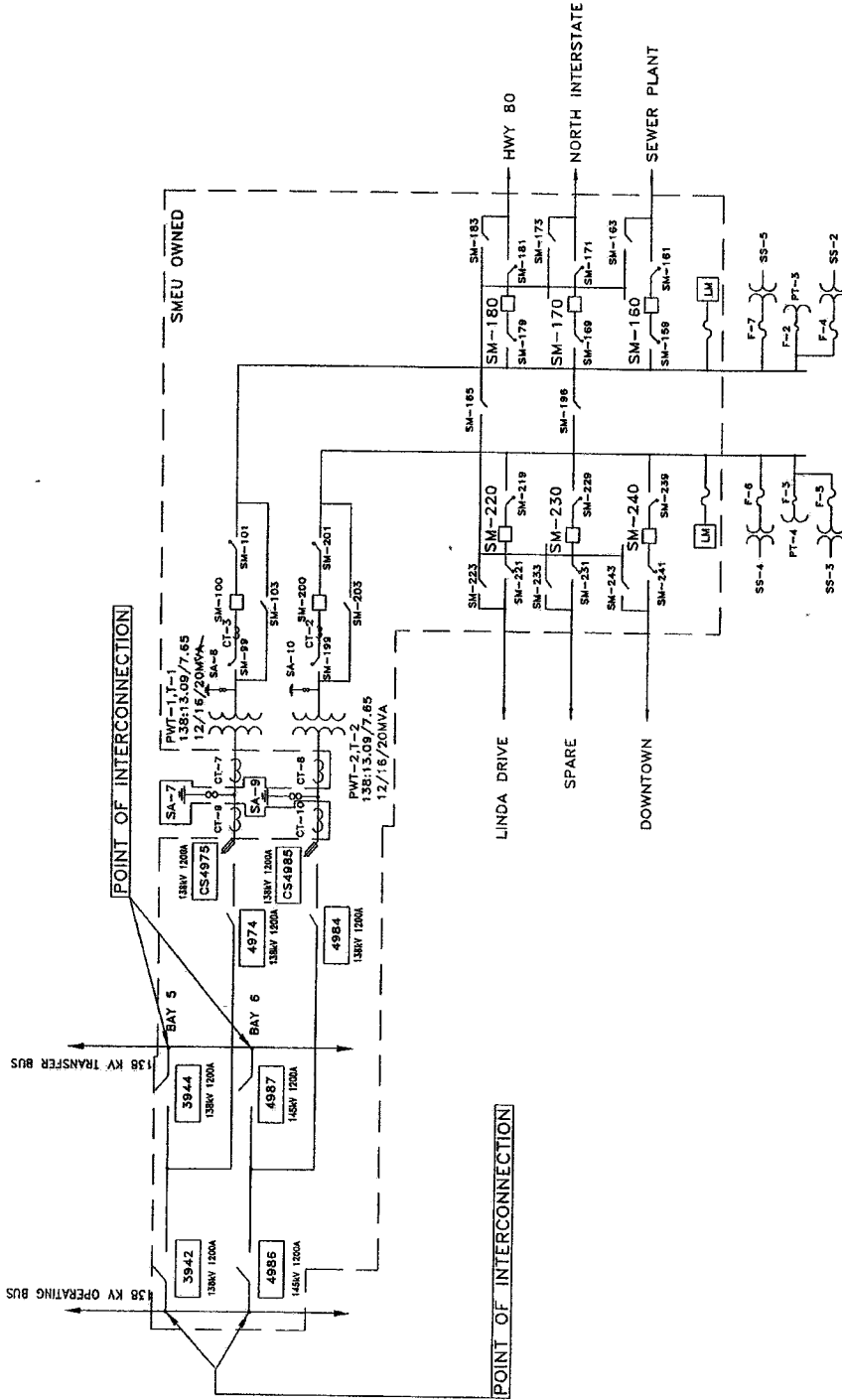

SAN MARCOS SUBSTATION

THIS IS NOT A COMPLETE ONE-LINE DIAGRAM  
FOR A COMPLETE ONE-LINE DIAGRAM OF THIS  
SUBSTATION, REFER TO DWG. S179-E-1.

## FACILITY SCHEDULE NO. 7

1. **Name:** Canyon Substation
2. **Facility Location:** The Canyon Substation is located at 2349 N. IH 35, San Marcos, Hays County, Texas 78666.
3. **Points of Interconnection:** There are four (4) Points of Interconnection in the Canyon Substation generally described as:
  - where the jumper from the 12.5 kV operating bus bolts to the four hole pad on switch CA-9 at breaker CA-10.
  - where the jumper from the 12.5 kV transfer bus bolts to the four hole pad on switch CA-13 at breaker CA-10.
  - where the jumper from the 12.5 kV operating bus bolts to the four hole pad on switch CA-19 at breaker CA-20.
  - where the jumper from the 12.5 kV transfer bus bolts to the four hole pad on switch CA-23 at breaker CA-20.
4. **Transformation Services Provided by LCRA TSC:** No
5. **Metering Services Provided by LCRA TSC:** Yes
6. **Delivery Voltage:** 12.5 kV
7. **Metered Voltage and Location:** The metering voltage is 12.5 kV. The metering current transformer is located inside PWT-1, T-3. The bus potential transformer is located on the 12.5 kV operating bus.
8. **One Line Diagram Attached:** Yes
9. **Description of Facilities Owned by Each Party:**

SMEU owns:

  - Three (3) distribution circuits including dead end insulators that attach to the dead end structure, conductors, and hardware
  - Two (2) distribution circuit breakers CA-10, and CA-20 including jumpers and protective relay packages
  - Three (3) distribution circuit breaker foundations in bays 1,2 and 3
  - Three (3) surge arresters
  - Nine (9) hook switches

LCRA TSC owns:

The Canyon Substation including, but not limited to, the following items:

- One (1) circuit switcher CS-20975 and associated disconnect switch 20974 and bypass switch 20977
- One (1) power transformer PWT-1, T-3 with associated surge arresters
- Four (4) distribution and total bays including A-frames, trusses, insulators, disconnect switches, surge arresters, 12.5 kV operating and transfer bus, bus potential transformer, metering current transformers and associated cabling
- Three (3) hook switches
- One (1) air break switch
- Control house and battery bank
- Station Service

10. **Operational Responsibilities of Each Party:** Each Party will be responsible for the operation of the equipment it owns.
11. **Maintenance Responsibilities of Each Party:** Each Party will be fully responsible for the maintenance of the equipment it owns.
12. **Other Terms and Conditions:** The City and LCRA TSC are to share access to the substation by LCRA TSC locks in the gate and in the control house doors.

# CANYON ONE-LINE DIAGRAM

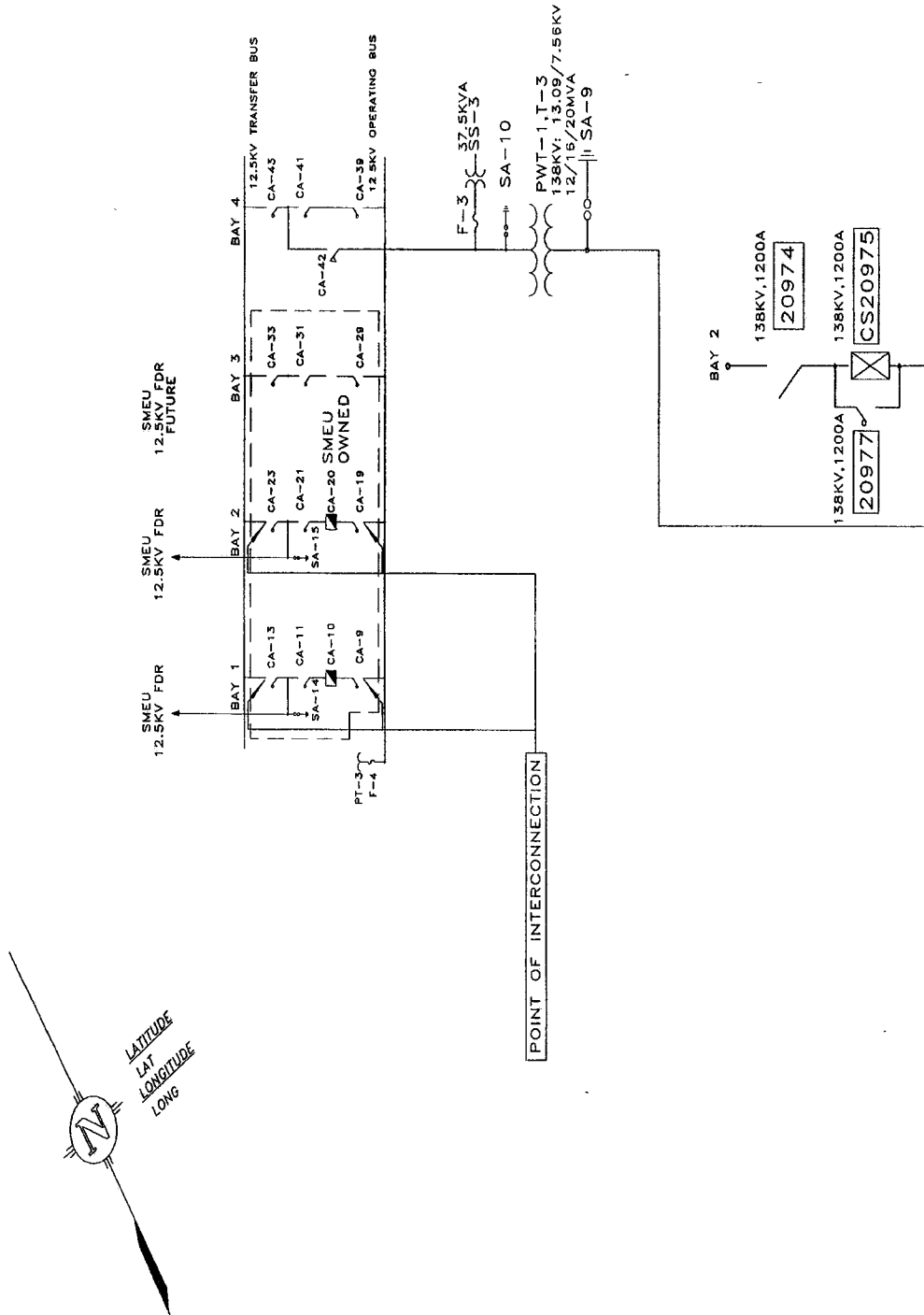

CANYON SUBSTATION

THIS IS NOT A COMPLETE ONE-LINE DIAGRAM  
FOR A COMPLETE ONE-LINE DIAGRAM OF THIS  
SUBSTATION, REFER TO DRAWING S229-E-0004.