



## Filing Receipt

**Received - 2021-09-23 03:22:14 PM**

**Control Number - 35077**

**ItemNumber - 1314**



Mickey Moon  
Assistant General Counsel

1111 Louisiana, Suite 4600  
Houston, Texas 77002  
Voice: (713) 207-7231  
Fax: (713) 454-7197  
mickey.moon@centerpointenergy.com

September 23, 2021

Filing Clerk  
Public Utility Commission of Texas  
1701 N. Congress Avenue  
P.O. Box 13326  
Austin, TX 78711-3326

**RE: Project No. 35077, ERCOT Standard Generation Interconnection Agreement  
between CenterPoint Energy Houston Electric, LLC and CG Wharton County LLC**

To whom it may concern:

Enclosed for filing in Project No. 35077 is the ERCOT Standard Generation Interconnection Agreement (SGIA) dated July 25, 2020 between CenterPoint Energy Houston Electric, LLC and CG Wharton County LLC. Also enclosed are the SGIA Amendment Provisions agreed to by the parties. This filing is made pursuant to 16 Tex. Admin. Code § 25.195(e).

Respectfully submitted,

A handwritten signature in black ink, appearing to read 'Mickey Moon', with a long horizontal flourish extending to the right.

Mickey Moon  
Assistant General Counsel  
CenterPoint Energy Houston Electric, LLC

Enclosures: (1) Executed SGIA Amendment Provisions  
(2) Executed SGIA

# EXHIBIT 1

**AGREEMENT TO ADOPT SGIA AMENDMENT PROVISIONS**

This Agreement to Adopt SGIA Amendment Provisions (this “Agreement”) is made as of this \_\_\_ day of July 23, 2020 between CenterPoint Energy Houston Electric, LLC (“CenterPoint Energy”) and CG Wharton County, LLC (“Generator”).

CenterPoint Energy and Generator are parties to that certain ERCOT Standard Generation Interconnection Agreement dated July 14, 2020 (the “SGIA”).

The SGIA is based on the form standard generation interconnection agreement approved by the Public Utility Commission of Texas (the “Commission”) on May 16, 2000 in Docket No. 22052 and is the required form of agreement to be used between transmission service providers (“TSPs”) and power generation companies “for the interconnection of new generating facilities” with a TSP’s transmission facilities pursuant to Section 25.195(a) of the Commission’s rules.

Section 25.195(a) of the Commission’s rules authorizes the parties to modify the terms of the SGIA.

CenterPoint Energy and Generator desire to modify Exhibit A of the SGIA (“Exhibit A”), which contains the general terms and conditions of the SGIA, by adopting the amendment provisions set forth in this Agreement (the “Amendment Provisions”) and to file this Agreement in Project No. 35077.

CenterPoint Energy and Generator, therefore, agree to adopt the following Amendment Provisions as amendments to Exhibit A:

**ARTICLE 1 AMENDMENT PROVISIONS**

Section 1.2. Section 1.2 of Exhibit A is amended to change the defined term to “Commercial Operation Date” and to replace the words “Generator declares” with the words “Generator notifies TSP.”

Section 1.3. Section 1.3 of Exhibit A is amended to change the Commission rule reference to 25.5(19).

Section 1.6. Section 1.6 of Exhibit A is amended and restated as follows: ““Facilities Study” shall mean the Full Interconnection Study Report dated April 29, 2020 prepared by the TSP in response to Generator’s interconnection request no. 22INR0205.

Section 1.9. Section 1.9 of Exhibit A is amended to change the Commission rule reference to 25.5(56).

Section 1.17. Section 1.17 of Exhibit A is amended to change the Commission rule reference to 25.191(d)(3).

Section 1.19. Section 1.19 of Exhibit A is amended to change the defined term to “System Security Screening Study” and to change the Commission rule reference to 25.198(c).

**ARTICLE 2 AMENDMENT PROVISIONS**

Section 2.1. Subsections B and C of Section 2.1 of Exhibit A are amended and restated as follows:

B. the TSP may terminate this Agreement (subject to Governmental Authority approval, if required) immediately upon written notice to the Generator if (i) all of the conditions precedent listed in Section 4.3 are not satisfied, and a new In-Service Date is not established pursuant to Section 4.5, within 12 months after the "Scheduled Start Date" specified in Exhibit "B" or (ii) the Commercial Operation Date does not, or the Generator notifies or otherwise informs the TSP that the Commercial Operation Date will not, occur within one year after the scheduled Commercial Operation Date reflected in Exhibit "B"; or

C. either Party may terminate this Agreement for a Default of the other Party in accordance with Section 10.6.

Section 2.2. Section 2.2 of Exhibit A is amended and restated as follows:

Termination Costs. If a Party elects to terminate this Agreement pursuant to Section 2.1 above, the Generator shall promptly pay all costs incurred (or committed to be incurred) by TSP for performance under this Agreement (including costs for the design, planning, licensing, procurement and construction of the TIF and for any upgrades to the TSP System to meet the requirements of the Plant), as of the date of the other Party's receipt of such notice of termination. The TSP may immediately exercise its rights under Section 8.3 and Exhibit "E" to recover such costs through the Security described therein; provided, however, if the Security is insufficient to cover such costs, then the Generator shall reimburse the TSP for any remaining amounts. In the event of termination by either Party, both Parties shall use commercially reasonable efforts to mitigate the damages and charges that they may incur as a consequence of termination. The provisions of Sections 2.2 and 2.3 shall survive termination of this Agreement.

#### ARTICLE 4 AMENDMENT PROVISIONS

Section 4.2. Section 4.2 of Exhibit A is deleted in its entirety (excluding the section number) and intentionally left blank to preserve the section numbering in Article 4.

Section 4.3. Section 4.3 of Exhibit A is amended and restated as follows:

Construction Commencement. The TSP shall commence design, equipment procurement and construction of the TIF as soon as practicable after all of the following conditions precedent are satisfied:

A. The TSP has completed the Facilities Study pursuant to the Facilities Study Agreement;

B. Approval of the appropriate Governmental Authority has been obtained for any facilities requiring regulatory approval (including any required CCN approvals);

C. Necessary real property rights, if any, have been obtained;

D. The TSP has received written notice to proceed with design, procurement and construction of the TIF (the "Notice to Proceed") from the Generator by the date specified in Exhibit "B";

E. The Generator has provided the Security to the TSP in accordance with Section 8.3 by the date specified in Exhibit "B"; and

F. If a CIAC is specified in Exhibit "C," the Generator has provided the CIAC to the TSP in accordance with Section 8.1 by the date specified in Exhibit "B."

Section 4.5. Section 4.5 of Exhibit A is amended and restated as follows:

Conditions Precedent Delay. To the extent any of the conditions precedent under Section 4.3 is not or cannot be satisfied in time for the TSP to meet the In-Service Date using Good Utility Practice, the Parties will negotiate in good faith to amend the time schedule in Exhibit "B" to establish a new In-Service Date.

#### **ARTICLE 6 AMENDMENT PROVISION**

Section 6.2. Section 6.2 of Exhibit A is amended and restated as follows:

Control Area. The Parties acknowledge and agree that the location of the TIF and GIF will be entirely within the ERCOT region and that the ERCOT region constitutes a single Control Area.

#### **ARTICLE 7 AMENDMENT PROVISION**

Section 7.3. Section 7.3 of Exhibit A is amended by replacing the term "System Security Study" with "System Security Screening Study."

#### **ARTICLE 8 AMENDMENT PROVISIONS**

Section 8.1. Section 8.1 of Exhibit A is amended and restated as follows:

Generator's Cost Responsibility. The Generator will acquire, construct, operate, test, maintain and own the Plant and the GIF at its sole expense. In addition, the Generator shall, by the date set out in Exhibit "B," make a contribution in aid of construction ("CIAC") in the amount set out in and for the TIF facilities described in Exhibit "C," if any, in accordance with PUCT Rules.

Section 8.2. Section 8.2 of Exhibit A is amended by replacing the phrase "Section 4.1.B" with "Sections 2.2 and 4.1.B."

Section 8.3. Section 8.3 of Exhibit A is amended and restated as follows:

Financial Security Arrangements. To secure the Generator's obligation to pay the termination costs described in Section 2.2 if this Agreement is terminated pursuant to Section 2.1, the TSP may require the Generator to pay a reasonable deposit or provide another means of security, to cover the costs of planning, licensing, procuring equipment and materials, and constructing the TIF. The required security arrangements are specified in Exhibit "E." The Generator shall deliver the financial security called for in Exhibit "E"

(the "Security") to the TSP by the date specified in Exhibit "B." Within five business days after the TSP receives notice of the Commercial Operation Date from the Generator, the TSP shall return the Security to the Generator. However, the TSP may retain an amount of the Security to cover the incremental difference between the TSP's actual out of pocket costs associated with the choice of Section 4.1.B over Section 4.1.A, pending a final PUCT Order as contemplated in Section 4.1.B(iii). If the Commercial Operation Date for the Plant does not occur within one year after the scheduled Commercial Operation Date identified in Exhibit "B" or if this Agreement is terminated in accordance with Section 2.1 and the TIF are not required, the TSP may, in accordance with the provisions of Section 2.2, retain as much of the Security as is required to cover the costs it incurred in planning, licensing, procuring equipment and materials, and constructing the TIF. If a cash deposit is provided as the Security pursuant to Exhibit "E," any repayment of such cash deposit shall include interest at a rate applicable to customer deposits as established from time to time by the PUCT or other Governmental Authority. If ERCOT requires the TSP to update the Facilities Study or conduct a new facilities study for the TIF, whether due to a delay in the Commercial Operation Date or otherwise, the TSP may increase the Security amount required from the Generator to cover any increase in the estimated cost of the TIF identified in such updated or new facilities study.

#### ARTICLE 9 AMENDMENT PROVISIONS

Section 9.1. Subsections B, E and I of Section 9.1 of Exhibit A are amended and restated as follows:

B. Commercial General Liability Insurance including for premises and operations, providing personal injury coverage; broad form property damage coverage; broad form blanket contractual liability coverage (including coverage for the contractual indemnification); products and completed operations coverage; coverage for explosion, collapse and underground hazards; independent contractors coverage; coverage for pollution to the extent normally available; coverage for punitive damages to the extent normally available; and cross liability coverage, with minimum limits of One Million Dollars (\$1,000,000) per occurrence/One Million Dollars (\$1,000,000) aggregate combined single limit for personal injury, bodily injury, including death and property damage.

E. The Commercial General Liability Insurance, Comprehensive Automobile Liability Insurance, and Excess Public Liability Insurance policies shall cover the other Party, its parent, associated and affiliated companies and their respective directors, officers, agents, servants and employees ("Other Party Group") as additional insured. All policies shall contain provisions whereby the insurers waive all rights of subrogation in accordance with the provisions of this Agreement against the Other Party Group, and each Party shall provide thirty (30) days advance written notice to Other Party Group prior to anniversary date of cancellation or any material change in coverage or condition.

I. Within ten (10) days following execution of this Agreement, and as soon as practicable after the end of each fiscal year or at the renewal of the insurance policy and in any event within ninety (90) days thereafter, each Party shall provide certification of all insurance required in this Agreement, executed by each insurer or by an authorized

representative of each insurer, or a letter of self-insurance executed by the Party's authorized representative.

#### **ARTICLE 10 AMENDMENT PROVISIONS**

Section 10.5. Subsection B of Section 10.5 of Exhibit A is amended and restated as follows:

B. Neither Party shall be considered to be in Default (as hereinafter defined) with respect to any obligation hereunder (including obligations under Article 4), other than the obligation to provide the Security or pay money when due, if prevented from fulfilling such obligation by Force Majeure. A Party unable to fulfill any obligation hereunder (other than an obligation to provide the Security or pay money when due) by reason of Force Majeure shall give notice and the full particulars of such Force Majeure to the other Party in writing or by telephone as soon as reasonably possible after the occurrence of the cause relied upon. Telephone notices given pursuant to this Section shall be confirmed in writing as soon as reasonably possible and shall specifically state full particulars of the Force Majeure, the time and date when the Force Majeure occurred and when the Force Majeure is reasonably expected to cease. The Party affected shall exercise due diligence to remove such disability with reasonable dispatch but shall not be required to accede or agree to any provision not satisfactory to it in order to settle and terminate a strike or other labor disturbance. The In-Service Date will be extended by one day for each day TIF construction is delayed due to Force Majeure.

Section 10.6. Subsection A of Section 10.6 of Exhibit A is amended and restated as follows:

A. The term "Default" shall mean the failure of either Party to perform any obligation in the time or manner provided in this Agreement. No Default shall exist where such failure to discharge an obligation (other than an obligation to provide the Security or to pay money) is the result of Force Majeure as defined in this Agreement or the result of an act or omission of the other Party. Upon a Default, the non-defaulting Party shall give written notice of such Default to the defaulting Party. Except as provided in Section 10.6.B, the defaulting Party shall have thirty (30) days from receipt of the Default notice within which to cure such Default; provided however, if such Default is not capable of cure within 30 days, the defaulting Party shall commence such cure within 30 days after receipt of the Default notice and continuously and diligently complete such cure within 90 days from receipt of the Default notice; and, if cured within such time, the Default specified in such notice shall cease to exist.



This Agreement and the Amendment Provisions herein are effective as of the effective date of the SGIA.

**CENTERPOINT ENERGY HOUSTON ELECTRIC, LLC**

**CG Wharton County, LLC**

By: DocuSigned by:  
David Lesar  
41F0FA6D0A8F494...  
Name: David Lesar  
Title: CEO

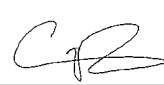
By: \_\_\_\_\_  
Name:   
Title: \_\_\_\_\_  
Digitally signed by  
Caton Fenz  
DN: cn=Caton Fenz,  
o=ConnectGen LLC,  
ou=Chief Executive  
Officer,  
email=cfenz@connectge  
nllc.com, c=US  
Date: 2020.07.26  
12:29:41 -05'00'

SL

# EXHIBIT 2



ERCOT STANDARD GENERATION  
INTERCONNECTION AGREEMENT

Between

CG Wharton County LLC

and

CenterPoint Energy Houston Electric, LLC

for

Sbranch Solar Project

July 14, 2020

## TABLE OF CONTENTS

<b>ERCOT STANDARD GENERATION INTERCONNECTION AGREEMENT.....</b>	<b>3</b>
EXHIBIT 'A' - TERMS AND CONDITIONS OF THE ERCOT STANDARD GENERATION INTERCONNECTION AGREEMENT.....	5
<i>ARTICLE 1. DEFINITIONS.....</i>	5
<i>ARTICLE 2. TERMINATION.....</i>	7
<i>ARTICLE 3. REGULATORY FILINGS.....</i>	8
<i>ARTICLE 4. INTERCONNECTION FACILITIES ENGINEERING, PROCUREMENT, AND CONSTRUCTION.....</i>	8
<i>ARTICLE 5. FACILITIES AND EQUIPMENT.....</i>	13
<i>ARTICLE 6. OPERATION AND MAINTENANCE.....</i>	17
<i>ARTICLE 7. DATA REQUIREMENTS.....</i>	20
<i>ARTICLE 8. PERFORMANCE OBLIGATION.....</i>	21
<i>ARTICLE 9. INSURANCE.....</i>	22
<i>ARTICLE 10. MISCELLANEOUS.....</i>	25
EXHIBIT 'B' - TIME SCHEDULE.....	35
EXHIBIT 'C' - INTERCONNECTION DETAILS.....	36
<i>Plant Name.....</i>	36
<i>Point of Interconnection Location.....</i>	36
<i>Delivery Voltage.....</i>	36
<i>Number and Size of Generating Units.....</i>	36
<i>Type of Generating Unit.....</i>	36
<i>Metering and Telemetry Equipment.....</i>	36
<i>Generator Interconnection Facilities.....</i>	36
<i>TSP Interconnection Facilities.....</i>	38
<i>Communications Facilities.....</i>	39
<i>System Protection Equipment.....</i>	39
<i>Inputs to Telemetry Equipment.....</i>	39
<i>Supplemental Terms and Conditions.....</i>	40
<i>Special Operating Conditions.....</i>	42
<i>Cost Estimate Differences.....</i>	43
EXHIBIT 'D' - NOTICE AND EFT INFORMATION.....	44
EXHIBIT 'E' - SECURITY ARRANGEMENT DETAILS.....	45
EXHIBIT 'F' - OUTAGE AND CLEARANCE COORDINATION PROCEDURES.....	46
EXHIBIT 'G' - TELEMETRY SPECIFICATION.....	47
EXHIBIT 'H' - ATTACHED DRAWINGS.....	48
EXHIBIT 'I' - SPECIFICATION FOR CUSTOMER OWNED 138kV SUBSTATION DESIGN.....	49

**ERCOT STANDARD GENERATION INTERCONNECTION AGREEMENT**

This Standard Generation Interconnection Agreement is made and entered into this 25 day of July, 2020, between *CenterPoint Energy Houston Electric* (“Transmission Service Provider”) and CG Wharton County LLC (“Generator”), hereinafter individually referred to as “Party,” and collectively referred to as “Parties.” In consideration of the mutual covenants and agreements herein contained, the Parties hereto agree as follows:

Transmission Service Provider represents that it is a public utility that owns and operates facilities for the transmission and distribution of electricity. Generator represents that it will own and operate the Plant. Pursuant to the terms and conditions of this Agreement, Transmission Service Provider shall interconnect Generator’s Plant with Transmission Service Provider’s System consistent with the Facilities Study Agreement executed between the Parties on July 1, 2019.

This Agreement applies only to the Plant and the Parties’ interconnection facilities as identified in Exhibit “C”.

This Agreement shall become effective on July 25, 2020, subject to Governmental Authority approval, if required, and shall continue in full force and effect until terminated in accordance with Exhibit “A”.

This Agreement will be subject to the following, all of which are incorporated herein:

- A. The “Terms and Conditions of the ERCOT Standard Generation Interconnection Agreement” attached hereto as Exhibit “A”;
- B. The ERCOT Requirements (unless expressly stated herein, where the ERCOT Requirements are in conflict with this Agreement, the ERCOT Requirements shall prevail);
- C. The PUCT Rules (where the PUCT Rules are in conflict with this Agreement, the PUCT Rules shall prevail);
- D. The Time Schedule attached hereto as Exhibit “B”;
- E. The Interconnection Details attached hereto as Exhibit “C”;
- F. The notice requirements attached hereto as Exhibit “D”;
- G. The Security Arrangement Details attached hereto as Exhibit “E”;
- H. The Transmission Service Provider’s “Outage and Clearance Coordination Procedure”, as it may be updated from time to time, the current version of which is attached hereto as Exhibit “F”;
- I. The Transmission Service Provider’s “Telemetry Specification”, specification 007-400-02, as it may be updated from time to time, the current version of which is attached hereto as Exhibit “G”; and
- J. Selected drawings related to the interconnection between Plant and Transmission Service Provider’s System, as they may be updated from time to time, the current versions of which are attached hereto as Exhibit “H”.

CenterPoint Energy Contract #INT-20-197A

K. The Transmission Service Provider's "Specification for Customer 138 kV Substation Design", specification 007-231-14, as it may be updated from time to time, the current version of which is attached hereto as Exhibit "I".

IN WITNESS WHEREOF, the Parties have executed this Agreement in duplicate originals, each of which shall constitute and be an original effective Agreement between the Parties.

**CG WHARTON COUNTY, LLC**

**CENTERPOINT ENERGY HOUSTON ELECTRIC, LLC**

By: \_\_\_\_\_  
Digitally signed by  
Caton Fenz  
DN: cn=Caton Fenz,  
~~o=ConnectGen LLC,~~ SL  
ou=Chief Executive  
Officer,  
email=cfenz@connectge  
nllc.com, c=US  
Date: 2020.07.26  
12:29:41 -05'00'  
Title: \_\_\_\_\_  
Date: \_\_\_\_\_

By: \_\_\_\_\_  
DocuSigned by:  
David Usar  
41F0FA6D0A8F494...  
Title: CEO  
Date: July 22, 2020

**Exhibit “A”  
Terms and Conditions of the ERCOT Standard Generation Interconnection  
Agreement**

**ARTICLE 1. DEFINITIONS**

Capitalized terms shall have the meanings as set forth below, except as otherwise specified in the Agreement:

1.1 “CCN” shall mean a Certificate of Convenience and Necessity issued by the PUCT.

1.2 “Commercial Operation” shall mean the date on which Generator declares that the construction of the Plant has been substantially completed, Trial Operation of the Plant has been completed, and the Plant is ready for dispatch.

1.3 “Control Area” shall have the meaning ascribed thereto in PUCT Rule 25.5(8) or its successor.

1.4 “ERCOT” shall mean the Electric Reliability Council of Texas, Inc.

1.5 “ERCOT Requirements” means the ERCOT Operating Guides, ISO Generation Interconnection Procedures as well as any other documents adopted by the ISO or ERCOT relating to the interconnection and operation of generators and transmission systems in ERCOT as amended from time to time, and any successors thereto. Any requirement in the foregoing documents imposed upon generation entities or generation facilities shall become the responsibility of the Generator, and any requirements imposed on transmission providers or transmission facilities shall become the responsibility of the TSP.

1.6 “Facilities Study” shall have the meaning as described in PUCT Rule 25.198(g) or its successor.

1.7 “Facilities Study Agreement” shall mean an agreement executed by the Parties relating to the performance of the Facilities Study.

1.8 “GIF” shall mean Generator’s interconnection facilities as described in Exhibit “C.”

1.9 “Good Utility Practice” shall have the meaning described in PUCT Rule 25.5(23) or its successor.

1.10 “Governmental Authority(ies)” shall mean any federal, state, local or municipal body having jurisdiction over a Party.

1.11 “In-Service Date” shall be the date, as reflected in Exhibit “B,” that the TIF will be ready to connect to the GIF.

1.12 “ISO” shall mean the ERCOT Independent System Operator.

1.13 “Plant” shall mean the electric generation facility owned and operated by the Generator, as specified in Exhibit “C.”

1.14 “Point of Interconnection” shall mean the location(s) where the GIF connects to the TIF as negotiated and defined by the Parties and as shown on Exhibit “C” of this Agreement.

1.15 “PUCT” shall mean the Public Utility Commission of Texas.

1.16 “PUCT Rules” shall mean the Substantive Rules of the PUCT.

1.17 “Reasonable Efforts” shall mean the use of Good Utility Practice and the exercise of due diligence (pursuant to PUCT Rule 25.196(e)).

1.18 “System Protection Equipment” shall mean those facilities located within the TIF and the GIF as described in Section 5.6 and Exhibit “C.”

1.19 “System Security Study” shall have the meaning as described in PUCT Rule 25.198(f) or its successor.



1.20 “TCOS” shall mean the TSP’s transmission cost of service as allowed by the applicable Governmental Authority.

1.21 “TIF” shall mean the TSP’s interconnection facilities as described in Exhibit “C” to this Agreement.

1.22 “Trial Operation” shall mean the process by which the Generator is engaged in on-site test operations and commissioning of the Plant prior to Commercial Operation.

1.23 “TSP” shall mean the Transmission Service Provider.

1.24 “TSP System” shall mean the electric transmission facilities, including the TIF, and all associated equipment and facilities owned and/or operated by the TSP.

## **ARTICLE 2. TERMINATION**

2.1 Termination Procedures. This Agreement may be terminated as follows:

A. the Generator may terminate this Agreement after giving the TSP thirty (30) days advance written notice; or

B. the TSP may terminate this Agreement (subject to Governmental Authority approval, if required) on written notice to the Generator if the Generator’s Plant has not achieved Commercial Operation within one year after the scheduled Commercial Operation date reflected in Exhibit “B”; or

C. either Party may terminate this Agreement in accordance with Section 10.6.

2.2 Termination Costs. If a Party elects to terminate the Agreement pursuant to Section 2.1 above, the Generator shall pay all costs incurred (or committed to be incurred) by TSP, as of the date of the other Party’s receipt of such notice of termination, that are the responsibility of the Generator under this Agreement. In the event of termination by either Party, both Parties shall use commercially reasonable efforts to mitigate the damages and

charges that they may incur as a consequence of termination. The provisions of the Sections 2.2 and 2.3 shall survive termination of the Agreement.

2.3 Disconnection. Upon termination of this Agreement, the Parties will disconnect the GIF from the TIF.

### **ARTICLE 3. REGULATORY FILINGS**

3.1 Filing. The TSP shall file this executed Agreement with the appropriate Governmental Authority, if required. Any portions of this Agreement asserted by Generator to contain competitively sensitive commercial or financial information shall be filed by the TSP identified as “confidential” under seal stating, for the TSP’s showing of good cause, that Generator asserts such information is confidential information and has requested such filing under seal. If requested by the TSP, Generator shall provide the TSP, in writing, with the Generator’s basis for asserting that the information referred to in this Section 3.1 is competitively sensitive information, and the TSP may disclose such writing to the appropriate Governmental Authority.

3.2 Regulatory Approvals. Unless exempt, the TSP shall timely request ISO and all regulatory approvals necessary for it to carry out its responsibilities under this Agreement. Such approvals shall include any CCN required for the construction of the TIF.

### **ARTICLE 4. INTERCONNECTION FACILITIES ENGINEERING, PROCUREMENT, AND CONSTRUCTION**

4.1 Options. The Generator shall select one of the following options (subsection A or subsection B) and include the selected option in Exhibit “B” for completion of the TIF:

## CenterPoint Energy Contract #INT-20-197A

A. The TSP shall design, procure, and construct the TIF, using Reasonable Efforts to complete the TIF by the In-Service Date reflected in Exhibit "B." The TSP will utilize its own resources and will contract for additional resources, as reasonably necessary, to meet the In-Service Date. Such resources shall include, as the TSP believes is reasonable, use of other contractors, other equipment suppliers, other material suppliers, additional contract personnel, additional payments to contractors for expedited work, and premiums paid to equipment and material suppliers for expedited delivery. The TSP shall not be required to undertake any initiative which is inconsistent with its standard safety practices, its material and equipment specifications, its design criteria and construction procedures, its labor agreements, applicable laws and regulations, and ERCOT Requirements. In the event the TSP reasonably expects that it will not be able to complete the TIF by the In-Service Date, the TSP will promptly provide written notice to the Generator and will undertake Reasonable Efforts to meet the earliest date thereafter.

B. (i) The TSP shall design, procure, and construct the TIF by the In-Service Date reflected in Exhibit "B." The Parties acknowledge that the In-Service Date was either agreed upon through good faith negotiations or designated by the Generator upon failure of the Parties to agree. In the process of negotiating the In-Service Date, Generator will request a date upon which it reasonably expects it will be ready to begin use of the TIF and upon which it reasonably expects to begin doing so. Any date designated by the Generator shall in no event be less than fifteen months from the date that all conditions of Sections 4.2 and 4.3 have been satisfied. The designated In-Service Date will be extended day for day for each day that the ISO refuses to grant clearances to install equipment. If the TSP fails to

complete the TIF by the In-Service Date reflected in Exhibit "B," the TSP shall pay the Generator liquidated damages in accordance with this Section 4.1.B.

(ii) The Parties agree that actual damages to the Generator, in the event the TIF are not completed by the In-Service Date, may include Generator's fixed operation and maintenance costs and lost opportunity costs. Such actual damages are uncertain and impossible to determine at this time. The Parties agree that, because of such uncertainty, any liquidated damages paid by the TSP to the Generator shall be an amount equal to  $\frac{1}{2}$  of 1% of the actual cost of the TIF, per day. However, in no event shall the total liquidated damages exceed 20% of the actual cost of the TIF. The Parties agree that such liquidated damages are less than the Generator's actual damages. The Parties agree that the foregoing payments will be made by the TSP to the Generator as just compensation for the damages caused to the Generator, which actual damages are uncertain and impossible to determine at this time, and as reasonable liquidated damages, but not as a penalty or a method to secure performance of this Agreement.

(iii) The TSP shall apply to have the full costs of the TIF included in TCOS. If the PUCT issues a final, appealable order excluding from TCOS any portion of the TIF costs, including higher contractor and vendor costs due to liquidated damage provisions in those contracts and insurance costs to cover liquidated damages, which costs may have been reasonably incurred but which the PUCT finds should not be recovered through TCOS, the Generator shall reimburse the TSP for such costs in an amount not to exceed the difference between the TSP's estimate of the cost of the TIF under section 4.1.A and the TSP's estimate of the cost of the TIF under Section 4.1.B as reflected in Exhibit "C." Such costs shall be estimated using Good Utility Practice.

## CenterPoint Energy Contract #INT-20-197A

(iv) No liquidated damages shall be paid to Generator if the Generator is not ready to commence use of the TIF for the delivery of power to the Plant for Trial Operation or export of power from the Plant on the In-Service Date, unless the Generator would have been able to commence use of the TIF for the delivery of power to the Plant for Trial Operation or export of power from the Plant but for TSP's delay.

(v) If the In-Service Date has been designated by the Generator upon a failure of the Parties to agree on the In-Service Date, the TSP may, at its option, require the Generator to subcontract with the TSP for all or part of the design, procurement and construction of the TIF in accordance with the TSP's standard subcontractor agreements. In such event, the TSP shall be subject to the payment of liquidated damages to the Generator only if the In-Service Date is not met solely due to the TSP's failure to complete the portion of the TIF for which the TSP has retained responsibility. It is the intent of this subsection to give the TSP full control of the contents and quality of the TIF. To the extent the Generator acts as a subcontractor to the TSP, the following will apply: 1) The Generator shall engineer, procure equipment, and construct the TIF (or portions thereof) using Good Utility Practice and using standards and specifications provided in advance by the TSP; 2) In its engineering, procurement and construction of the TIF, the Generator shall comply with all requirements of law to which the TSP would be subject in the engineering, procurement or construction of the TIF; 3) The TSP shall review and approve the engineering design, acceptance tests of equipment, and the construction of the TIF; 4) The TSP shall have the right to approve and accept for operation the TIF in accordance with the standards and specifications provided in advance by the TSP, such approval and acceptance shall not be unreasonably withheld, conditioned, or delayed; 5) Should any

## CenterPoint Energy Contract #INT-20-197A

phase of the engineering, equipment procurement, or construction of the TIF, including selection of subcontractors, not meet the standards and specifications provided by the TSP, and therefore be deemed unacceptable, then the Generator shall be obligated to remedy that portion of the TIF or selection of subcontractors that is deemed unacceptable, the TSP's approval of the Generator's selection of subcontractors will not be unreasonably withheld, conditioned or delayed; and 6) Once the TIF is accepted for operation by the TSP, then the TSP shall reimburse the Generator for the reasonable and necessary costs incurred by the Generator to complete the TIF, not to exceed the amount specified in the subcontract. Such reimbursement shall be made within thirty days after receipt of the invoice, unless otherwise agreed to by the Parties.

4.2 Equipment Procurement. If responsibility for construction of the TIF is borne by the TSP, then the TSP shall commence design of the TIF and procure necessary equipment within a reasonable time after all of the following conditions are satisfied:

- A. The TSP has completed the Facilities Study pursuant to the Facilities Study Agreement;
- B. The TSP has received written authorization to proceed with design and procurement from the Generator by the date specified in Exhibit "B"; and
- C. The Generator has provided security to the TSP in accordance with Section 8.3 by the dates specified in Exhibit "B."

4.3 Construction Commencement. The TSP shall commence construction of the TIF as soon as practicable after the following additional conditions are satisfied:

- A. Approval of the appropriate Governmental Authority has been obtained for any facilities requiring regulatory approval;

- B. Necessary real property rights, if any, have been obtained;
- C. The TSP has received written authorization to proceed with construction from the Generator by the date specified in Exhibit “B”; and
- D. The Generator has provided security to the TSP in accordance with Section 8.3 by the dates specified in Exhibit “B.”

4.4 Work Progress. The Parties will keep each other advised periodically as to the progress of their respective design, procurement and construction efforts. If, at any time, the Generator becomes aware that the completion of the TIF will not be required until after the specified In-Service Date, the Generator will promptly provide written notice to the TSP of a new, later In-Service Date.

4.5 Conditions Precedent Delay. To the extent this Agreement incorporates a specified In-Service Date and the Generator fails to satisfy conditions precedent under Sections 4.2 and 4.3 so that the TSP may meet the In-Service Date, the Parties will negotiate in good faith to establish a new schedule for completion of the TIF.

## **ARTICLE 5. FACILITIES AND EQUIPMENT**

5.1 Information Exchange. The Parties shall exchange information and mutually agree upon the design and compatibility of the Parties’ interconnection facilities. The Parties shall work diligently and in good faith to make any necessary design changes to ensure compatibility of the GIF to the TSP System.

5.2 GIF Construction. Generator agrees to cause the GIF to be designed and constructed in accordance with Good Utility Practice, ERCOT Requirements and the National Electrical Safety Code in effect at the time of construction. Within one-hundred and twenty (120) days after Commercial Operation, unless the Parties agree on another mutually

acceptable deadline, the Generator shall deliver to the TSP the following “as-built” drawings, information and documents for the GIF: a one-line diagram, a site plan showing the Plant and the GIF, plan and elevation drawings showing the layout of the GIF, a relay functional diagram, relaying AC and DC schematic wiring diagrams and relay settings for all facilities associated with the Generator’s main-power transformers, the facilities connecting the Generator to the main power transformers and the GIF, and the impedances (determined by factory tests) for the associated main power transformers and the generators.

5.3 TIF Construction. The TSP agrees to cause the TIF to be designed and constructed in accordance with Good Utility Practice, ERCOT Requirements and the National Electrical Safety Code in effect at the time of construction.

5.4 Equipment Changes. For facilities not described in Exhibit “C,” if either Party makes equipment changes to the Plant, the GIF, the TIF or the TSP System which it knows will affect the operation or performance of the other Party’s interconnection facilities, the Parties agree to notify the other Party, in writing, of such changes. Such changes shall be made in accordance with ERCOT Requirements and coordinated between the Parties.

5.5 Metering, Telemetry and Communications Requirements.

A. Metering and telemetry of data will be accomplished in accordance with ERCOT Requirements. The specific metering, telemetry and communications equipment to be installed and data to be telemetered are described in Exhibit “C.”

B. At the Point of Interconnection, the metering and telemetry equipment shall be owned by the TSP. However, the TSP shall provide the Generator with metering and telemetry values in accordance with ERCOT Requirements.



## CenterPoint Energy Contract #INT-20-197A

C. A minimum set of inputs to the telemetry equipment are specified in Exhibit “C.” Additional sets of inputs may be subsequently mutually agreed upon.

D. The TSP will notify the Generator at least five (5) working days in advance of any planned maintenance, inspection, testing, or calibration of the metering equipment, unless otherwise agreed to in writing. The Generator, or its designated representative, shall have the right to be present for these activities and to receive copies of any documents related to the procedures and results.

E. Prior to the connection of the GIF to the TIF, acceptance tests will be performed by the owning Party to ensure the proper functioning of all metering, telemetry and communications equipment associated with the Point of Interconnection and both Parties’ interconnection facilities, and to verify the accuracy of data being received by the TSP, the Control Area(s) in which the Plant and the TSP are located and the Generator. All acceptance tests will be performed consistent with ERCOT Requirements.

F. The TSP shall, in accordance with Good Utility Practice and ERCOT Requirements, specify communications facilities, including those necessary to transmit data from the metering equipment to the TSP, that are necessary for the effective operation of the Plant and the GIF with the TSP System. Such communication facilities shall be included in Exhibit “C.” The Generator shall make arrangements to procure and bear the cost of such facilities.

G. Any changes to the meters, telemetry equipment, voltage transformers, current transformers, and associated panels, hardware, conduit and cable, which will affect the data being received by the other Party must be mutually agreed to by the Parties.

H. Each Party will promptly advise the other Party if it detects or otherwise learns of any metering, telemetry or communications equipment errors or malfunctions that require the attention and/or correction by the other Party. The Party owning such equipment shall correct such error or malfunction as soon as reasonably feasible in accordance with ERCOT Requirements.

5.6 System Protection and Other Controls Requirements.

A. Each Party's facilities shall be designed to isolate any fault, or to correct or isolate any abnormality, that would negatively affect the other Party's system or other entities connected to the TSP System.

B. The Generator shall be responsible for protection of its facilities consistent with ERCOT Requirements.

C. Each Party's protective relay design shall incorporate the necessary test switches to perform the tests required in Section 5.6.F. The required test switches will be placed such that they allow operation of lockout relays while preventing breaker failure schemes from operating and causing unnecessary breaker operations and tripping the Generator's units.

D. Recording equipment shall be installed to analyze all system disturbances in accordance with ERCOT Requirements.

E. Each Party will test, operate and maintain System Protection Equipment in accordance with ERCOT Requirements. Each Party will provide reasonable notice to the other Party of any testing of its System Protection Equipment allowing such other Party the opportunity to have representatives present during testing of its System Protection Equipment.

F. Prior to the In-Service Date, and again prior to Commercial Operation, each Party or its agent shall perform a complete calibration test and functional trip test of the System Protection Equipment. At intervals suggested by Good Utility Practice or at intervals described in the ERCOT Requirements if so defined therein, and following any apparent malfunction of the System Protection Equipment, each Party shall perform both calibration and functional trip tests of its System Protection Equipment. These tests do not require the tripping of any in-service generation unit. These tests do, however, require that all protective relays and lockout contacts be activated.

5.7 No Annexation. Any and all equipment placed on the premises of a Party shall be and remain the property of the Party providing such equipment regardless of the mode and manner of annexation or attachment to real property, unless otherwise mutually agreed by the Parties.

## **ARTICLE 6. OPERATION AND MAINTENANCE**

6.1 Operation and Maintenance of Interconnection Facilities. The Parties agree to operate and maintain their systems in accordance with Good Utility Practice, National Electrical Safety Code, the ERCOT Requirements, PUCT Rules and all applicable laws and regulations. Subject to any necessary ISO approval, each Party shall provide necessary equipment outages to allow the other Party to perform periodic maintenance, repair or replacement of its facilities. Such outages shall be scheduled at mutually agreeable times, unless conditions exist which a Party believes, in accordance with Good Utility Practice, may endanger persons or property. No changes will be made in the normal operation of the Point of Interconnection without the mutual agreement of the Parties except as

otherwise provided herein. All testing of the Plant that affects the operation of the Point of Interconnection shall be coordinated between the TSP, the Control Area(s) in which the Plant and the TSP are located, and the Generator and will be conducted in accordance with ERCOT Requirements.

6.2 Control Area Notification. At least six months before Trial Operation, the Generator shall notify the TSP in writing of the Control Area in which it will be located. If the Generator elects to be located in a Control Area other than the Control Area in which the TSP is located, all necessary agreements, including but not limited to remote control area generator interchange agreements, if applicable, and appropriate measures under such agreements, shall be executed and implemented prior to the placement of the Plant in the other Control Area. The Parties will diligently cooperate with one another to enable such agreements to be executed and implemented on a schedule necessary to meet the Trial Operation date specified in Exhibit "B."

6.3 Land Rights and Easements. Terms and conditions addressing the rights of the TSP and the Generator regarding any facilities located on the other Party's property shall be addressed in a separate, duly executed and recorded easement agreement between the Parties. Prior to Commercial Operation, the Parties will mutually agree upon procedures to govern access to each other's property as necessary for the Parties to fulfill their obligations hereunder.

6.4 Service Interruption. The Parties recognize that the interruption of service provisions of the PUCT Rules give TSP the right to disconnect the TSP System from the Plant under the conditions specified therein. The Generator will promptly disconnect the Plant from the TSP System when required by and in accordance with the PUCT Rules and

ERCOT Requirements.

6.5 Switching and Clearance.

A. Any switching or clearances needed on the TIF or the GIF will be done in accordance with ERCOT Requirements.

B. Any switching and clearance procedure necessary to comply with Good Utility Practice or ERCOT Requirements that may have specific application to the Plant shall be addressed in Exhibit "C."

6.6 Start-Up and Synchronization. Consistent with ERCOT Requirements and the Parties' mutually acceptable procedure, the Generator is responsible for the proper synchronization of the Plant to the TSP System.

6.7 Routine Operational Communications. On a timely basis, the Parties shall exchange all information necessary to comply with ERCOT Requirements.

6.8 Blackstart Operations. If the Plant is capable of blackstart operations, Generator will coordinate individual Plant start-up procedures consistent with ERCOT Requirements. Any blackstart operations shall be conducted in accordance with the blackstart criteria included in the ERCOT Requirements and the TSP Blackstart Plan on file with the ISO. Notwithstanding this section, the Generator is not required to have blackstart capability by virtue of this Agreement. If the Generator will have blackstart capability, then Generator shall provide and maintain an emergency communication system that will interface with the TSP during a blackstart condition.

6.9 Power System Stabilizers. The Generator shall procure, install, maintain and operate power system stabilizers if required to meet ERCOT Requirements and as described in Exhibit "C."

## ARTICLE 7. DATA REQUIREMENTS

7.1 Data Acquisition. The acquisition of data to realistically simulate the electrical behavior of system components is a fundamental requirement for the development of a reliable interconnected transmission system. Therefore, the TSP and the Generator shall be required to submit specific information regarding the electrical characteristics of their respective facilities to each other as described below in accordance with ERCOT Requirements.

7.2 Initial Data Submission by TSP. The initial data submission by the TSP shall occur no later than 120 days prior to Trial Operation and shall include transmission system data necessary to allow the Generator to select equipment and meet any system protection and stability requirements.

7.3 Initial Data Submission by Generator. The initial data submission by the Generator, including manufacturer data, shall occur no later than 90 days prior to the Trial Operation and shall include a completed copy of the following forms contained in the ISO's Generation Interconnection Procedure: (1) Plant Description/Data and (2) Generation Stability Data. It shall also include any additional data provided to the ISO for the System Security Study. Data in the initial submissions shall be the most current Plant design or expected performance data. Data submitted for stability models shall be compatible with the ISO standard models. If there is no compatible model, the Generator will work with an ISO designated consultant to develop and supply a standard model and associated data.

7.4 Data Supplementation. Prior to Commercial Operation, the Parties shall supplement their initial data submissions with any and all "as-built" Plant data or "as-tested" performance data which differs from the initial submissions or, alternatively,

written confirmation that no such differences exist. Subsequent to Commercial Operation, the Generator shall provide the TSP any data changes due to equipment replacement, repair, or adjustment. The TSP shall provide the Generator any data changes due to equipment replacement, repair, or adjustment in the directly connected substation or any adjacent TSP-owned substation that may affect the GIF equipment ratings, protection or operating requirements. The Parties shall provide such data no later than 30 days after the date of the actual change in equipment characteristics. Also, the Parties shall provide to each other a copy of any additional data later required by the ISO concerning these facilities.

7.5 Data Exchange. Each Party shall furnish to the other Party real-time and forecasted data as required by ERCOT Requirements. The Parties will cooperate with one another in the analysis of disturbances to either the Plant or the TSP's System by gathering and providing access to any information relating to any disturbance, including information from oscillography, protective relay targets, breaker operations and sequence of events records.

## **ARTICLE 8. PERFORMANCE OBLIGATION**

8.1 Generator's Cost Responsibility. The Generator will acquire, construct, operate, test, maintain and own the Plant and the GIF at its sole expense. In addition, the Generator may be required to make a contribution in aid of construction in the amount set out in and for the facilities described in Exhibit "C," if any, in accordance with PUCT Rules.

8.2 TSP's Cost Responsibility. The TSP will acquire, own, operate, test, and maintain the TIF at its sole expense, subject to the provisions of Section 4.1.B and the contribution in aid of construction provisions of Section 8.1 of this Agreement.

8.3 Financial Security Arrangements. The TSP may require the Generator to pay a reasonable deposit or provide another means of security, to cover the costs of planning, licensing, procuring equipment and materials, and constructing the TIF. The required security arrangements shall be specified in Exhibit “E.” Within five business days after the Plant achieves Commercial Operation with respect to the applicable Phase, the TSP shall return the deposit or security to the Generator relating to such Phase. However, the TSP may retain an amount to cover the incremental difference between the TSP’s actual out of pocket costs associated with the choice of Section 4.1.B over Section 4.1.A, pending a final PUCT Order as contemplated in Section 4.1.B(iii). If the Plant has not achieved Commercial Operation within one year after the scheduled Commercial Operation date identified in Exhibit “B” or if the Generator terminates this Agreement in accordance with Section 2.1 and the TIF are not required, the TSP may, subject to the provisions of Section 2.2, retain as much of the deposit or security as is required to cover the costs it incurred in planning, licensing, procuring equipment and materials, and constructing the TIF. If a cash deposit is made pursuant to Exhibit “E,” any repayment of such cash deposit shall include interest at a rate applicable to customer deposits as established from time to time by the PUCT or other Governmental Authority.

## ARTICLE 9. INSURANCE

9.1 Each Party shall, at its own expense, maintain in force throughout the period of this Agreement and until released by the other Party the following minimum insurance coverages, with insurers authorized to do business in Texas:

A. Employers Liability and Worker’s Compensation Insurance providing statutory benefits in accordance with the laws and regulations of the State of Texas. The



## CenterPoint Energy Contract #INT-20-197A

minimum limits for the Employer's Liability insurance shall be One Million Dollars (\$1,000,000) each accident bodily injury by accident, One Million Dollars (\$1,000,000) each employee bodily injury by disease, and One Million Dollars (\$1,000,000) policy limit bodily injury by disease.

B. Commercial General Liability Insurance including premises and operations, personal injury, broad form property damage, broad form blanket contractual liability coverage (including coverage for the contractual indemnification) products and completed operations coverage, coverage for explosion, collapse and underground hazards, independent contractors coverage, coverage for pollution to the extent normally available and punitive damages to the extent normally available and a cross liability endorsement, with minimum limits of One Million Dollars (\$1,000,000) per occurrence/One Million Dollars (\$1,000,000) aggregate combined single limit for personal injury, bodily injury, including death and property damage.

C. Comprehensive Automobile Liability Insurance for coverage of owned, non-owned and hired vehicles, trailers or semi-trailers designed for travel on public roads, with a minimum combined single limit of One Million Dollars (\$1,000,000) per occurrence for bodily injury, including death, and property damage.

D. Excess Public Liability Insurance over and above the Employer's Liability, Commercial General Liability and Comprehensive Automobile Liability Insurance coverage, with a minimum combined single limit of Twenty Million Dollars (\$20,000,000) per occurrence/Twenty Million Dollars (\$20,000,000) aggregate.

E. The Commercial General Liability Insurance, Comprehensive Automobile Liability Insurance, and Excess Public Liability Insurance policies shall name the other

Party, its parent, associated and affiliated companies and their respective directors, officers, agents, servants and employees (“Other Party Group”) as additional insured. All policies shall contain provisions whereby the insurers waive all rights of subrogation in accordance with the provisions of this Agreement against the Other Party Group and provide thirty (30) days advance written notice to Other Party Group prior to anniversary date of cancellation or any material change in coverage or condition.

F. The Commercial General Liability Insurance, Comprehensive Automobile Liability Insurance and Excess Public Liability Insurance policies shall contain provisions that specify that the policies are primary and shall apply to such extent without consideration for other policies separately carried and shall state that each insured is provided coverage as though a separate policy had been issued to each, except the insurer’s liability shall not be increased beyond the amount for which the insurer would have been liable had only one insured been covered. Each Party shall be responsible for its respective deductibles or retentions.

G. The Commercial General Liability Insurance, Comprehensive Automobile Liability Insurance and Excess Public Liability Insurance policies, if written on a Claims First Made basis, shall be maintained in full force and effect for two (2) years after termination of this Agreement, which coverage may be in the form of tail coverage or extended reporting period coverage if agreed by the Parties.

H. The requirements contained herein as to the types and limits of all insurance to be maintained by the Parties are not intended to and shall not in any manner, limit or qualify the liabilities and obligations assumed by the Parties under this Agreement.

## CenterPoint Energy Contract #INT-20-197A

I. Within ten (10) days following execution of this Agreement, and as soon as practicable after the end of each fiscal year or at the renewal of the insurance policy and in any event within ninety (90) days thereafter, each Party shall provide certification of all insurance required in this Agreement, executed by each insurer or by an authorized representative of each insurer.

J. Notwithstanding the foregoing, each Party may self-insure to the extent it maintains a self-insurance program; provided that, such Party's senior secured debt is rated at investment grade, or better, by Standard & Poor's. For any period of time that a Party's senior secured debt is unrated by Standard & Poor's or is rated at less than investment grade by Standard & Poor's, such Party shall comply with the insurance requirements applicable to it under Sections 9.1.A through 9.1.I. In the event that a Party is permitted to self-insure pursuant to this Section 9.1.J, it shall not be required to comply with the insurance requirements applicable to it under Sections 9.1.A through 9.1.I.

K. The Parties agree to report to each other in writing as soon as practical all accidents or occurrences resulting in injuries to any person, including death, and any property damage arising out of this Agreement.

## **ARTICLE 10. MISCELLANEOUS**

### **10.1 Governing Law and Applicable Tariffs.**

A. This Agreement for all purposes shall be construed in accordance with and governed by the laws of the State of Texas, excluding conflicts of law principles that would refer to the laws of another jurisdiction. The Parties submit to the jurisdiction of the federal and state courts in the State of Texas.

B. This Agreement is subject to all valid, applicable rules, regulations and orders of, and tariffs approved by, duly constituted Governmental Authorities.

C. Each Party expressly reserves the right to seek changes in, appeal, or otherwise contest any laws, orders, rules, or regulations of a Governmental Authority.

10.2 No Other Services. This Agreement is applicable only to the interconnection of the Plant to the TSP System at the Point of Interconnection and does not obligate either Party to provide, or entitle either Party to receive, any service not expressly provided for herein. Each Party is responsible for making the arrangements necessary for it to receive any other service that it may desire from the other Party or any third party. This Agreement does not address the sale or purchase of any electric energy, transmission service or ancillary services by either Party, either before or after Commercial Operation.

10.3 Entire Agreement. This Agreement, including all Exhibits, Attachments and Schedules attached hereto, constitutes the entire agreement between the Parties with reference to the subject matter hereof, and supersedes all prior and contemporaneous understandings or agreements, oral or written, between the Parties with respect to the subject matter of this Agreement. There are no other agreements, representations, warranties, or covenants which constitute any part of the consideration for, or any condition to, either Party's compliance with its obligations under this Agreement. Notwithstanding the other provisions of this Section, the Facilities Study Agreement, if any, is unaffected by this Agreement.

10.4 Notices. Except as otherwise provided in Exhibit "D," any formal notice, demand or request provided for in this Agreement shall be in writing and shall be deemed properly served, given or made if delivered in person, or sent by either registered or certified mail,

postage prepaid, overnight mail or fax to the address or number identified on Exhibit “D” attached to this Agreement. Either Party may change the notice information on Exhibit “D” by giving five business days written notice prior to the effective date of the change.

10.5 Force Majeure.

A. The term “Force Majeure” as used herein shall mean any cause beyond the reasonable control of the Party claiming Force Majeure, and without the fault or negligence of such Party, which materially prevents or impairs the performance of such Party’s obligations hereunder, including but not limited to, storm, flood, lightning, earthquake, fire, explosion, failure or imminent threat of failure of facilities, civil disturbance, strike or other labor disturbance, sabotage, war, national emergency, or restraint by any Governmental Authority.

B. Neither Party shall be considered to be in Default (as hereinafter defined) with respect to any obligation hereunder (including obligations under Article 4), other than the obligation to pay money when due, if prevented from fulfilling such obligation by Force Majeure. A Party unable to fulfill any obligation hereunder (other than an obligation to pay money when due) by reason of Force Majeure shall give notice and the full particulars of such Force Majeure to the other Party in writing or by telephone as soon as reasonably possible after the occurrence of the cause relied upon. Telephone notices given pursuant to this Section shall be confirmed in writing as soon as reasonably possible and shall specifically state full particulars of the Force Majeure, the time and date when the Force Majeure occurred and when the Force Majeure is reasonably expected to cease. The Party affected shall exercise due diligence to remove such disability with reasonable dispatch,

but shall not be required to accede or agree to any provision not satisfactory to it in order to settle and terminate a strike or other labor disturbance.

#### 10.6 Default

A. The term “Default” shall mean the failure of either Party to perform any obligation in the time or manner provided in this Agreement. No Default shall exist where such failure to discharge an obligation (other than the payment of money) is the result of Force Majeure as defined in this Agreement or the result of an act or omission of the other Party. Upon a Default, the non-defaulting Party shall give written notice of such Default to the defaulting Party. Except as provided in Section 10.6.B, the defaulting Party shall have thirty (30) days from receipt of the Default notice within which to cure such Default; provided however, if such Default is not capable of cure within 30 days, the defaulting Party shall commence such cure within 30 days after notice and continuously and diligently complete such cure within 90 days from receipt of the Default notice; and, if cured within such time, the Default specified in such notice shall cease to exist.

B. If a Default is not cured as provided in this Section, or if a Default is not capable of being cured within the period provided for herein, the non-defaulting Party shall have the right to terminate this Agreement by written notice at any time until cure occurs, and be relieved of any further obligation hereunder and, whether or not that Party terminates this Agreement, to recover from the defaulting Party all amounts due hereunder, plus all other damages and remedies to which it is entitled at law or in equity. The provisions of this Section will survive termination of this Agreement.

10.7 Intrastate Operation. The operation of the Plant by Generator shall not cause there to be a synchronous or an asynchronous interconnection between ERCOT and any other

transmission facilities operated outside of ERCOT unless ordered by the Federal Energy Regulatory Commission under Section 210 of the Federal Power Act. The Parties recognize and agree that any such interconnection will constitute an adverse condition giving the TSP the right to immediately disconnect the TIF from the GIF, until such interconnection has been disconnected. The Generator will not be prohibited by this Section from interconnecting the Plant with facilities operated by the Comision Federal de Electricidad of Mexico, unless such interconnection would cause ERCOT utilities that are not “public utilities” under the Federal Power Act to become subject to the plenary jurisdiction of the Federal Energy Regulatory Commission.

10.8 No Third Party Beneficiaries. This Agreement is not intended to and does not create rights, remedies, or benefits of any character whatsoever in favor of any persons, corporations, associations, or entities other than the Parties, and the obligations herein assumed are solely for the use and benefit of the Parties, their successors in interest and, where permitted, their assigns.

10.9 No Waiver. The failure of a Party to this Agreement to insist, on any occasion, upon strict performance of any provision of this Agreement will not be considered a waiver of obligations, rights, or duties imposed upon the Parties. Termination or Default of this Agreement for any reason by the Generator shall not constitute a waiver of the Generator’s legal rights to obtain an interconnection from the TSP under a new interconnection agreement.

10.10 Headings. The descriptive headings of the various articles and sections of this Agreement have been inserted for convenience of reference only and are of no significance in the interpretation or construction of this Agreement.

10.11 Multiple Counterparts. This Agreement may be executed in two or more counterparts, each of which is deemed an original but all constitute one and the same instrument.

10.12 Amendment. This Agreement may be amended only upon mutual agreement of the Parties, which amendment will not be effective until reduced to writing and executed by the Parties.

10.13 No Partnership. This Agreement shall not be interpreted or construed to create an association, joint venture, agency relationship, or partnership between the Parties or to impose any partnership obligation or liability upon either Party. Neither Party shall have any right, power or authority to enter into any agreement or undertaking for, or act on behalf of, or to act as or be an agent or representative of, or to otherwise bind, the other Party.

10.14 Further Assurances. The Parties agree to (i) furnish upon request to each other such further information, (ii) execute and deliver to each other such other documents, and (iii) do such other acts and things, all as the other Party may reasonably request for the purpose of carrying out the intent of this Agreement and the documents referred to in this Agreement. Without limiting the generality of the foregoing, the TSP shall, at the Generator's expense, when reasonably requested to do so by the Generator at any time after the execution of this Agreement, prepare and provide such information in connection with this Agreement (including, if available, resolutions, certificates, opinions of counsel or other documents relating to the TSP's corporate authorization to enter into this Agreement and to undertake the obligations set out herein) as may be reasonably required by any potential lender to the Generator under a proposed loan agreement. The TSP will use



commercially reasonable efforts to obtain any opinion of counsel reasonably requested by Generator, but the TSP shall not be in Default of any obligation under this Agreement if the TSP is unable to provide an opinion of counsel that will satisfy any potential lender to the Generator. Specifically, upon the written request of one Party, the other Party shall provide the requesting Party with a letter stating whether or not, up to the date of the letter, that Party is satisfied with the performance of the requesting Party under this Agreement.

10.15 Indemnification and Liability. The indemnification and liability provisions of the PUCT Rule 25.202(b)(2) or its successor shall govern this Agreement.

10.16 Consequential Damages. OTHER THAN THE LIQUIDATED DAMAGES HERETOFORE DESCRIBED, IN NO EVENT SHALL EITHER PARTY BE LIABLE UNDER ANY PROVISION OF THIS AGREEMENT FOR ANY LOSSES, DAMAGES, COSTS OR EXPENSES FOR ANY SPECIAL, INDIRECT, INCIDENTAL, CONSEQUENTIAL, OR PUNITIVE DAMAGES, INCLUDING BUT NOT LIMITED TO LOSS OF PROFIT OR REVENUE, LOSS OF THE USE OF EQUIPMENT, COST OF CAPITAL, COST OF TEMPORARY EQUIPMENT OR SERVICES, WHETHER BASED IN WHOLE OR IN PART IN CONTRACT, IN TORT, INCLUDING NEGLIGENCE, STRICT LIABILITY, OR ANY OTHER THEORY OF LIABILITY; PROVIDED, HOWEVER, THAT DAMAGES FOR WHICH A PARTY MAY BE LIABLE TO THE OTHER PARTY UNDER ANOTHER AGREEMENT WILL NOT BE CONSIDERED TO BE SPECIAL, INDIRECT, INCIDENTAL, OR CONSEQUENTIAL DAMAGES HEREUNDER.

10.17 Assignment. This Agreement may be assigned by either Party only with the written consent of the other; provided that either Party may assign this Agreement without the

## CenterPoint Energy Contract #INT-20-197A

consent of the other Party to any affiliate of the assigning Party with an equal or greater credit rating and with the legal authority and operational ability to satisfy the obligations of the assigning Party under this Agreement; and provided further that the Generator shall have the right to assign this Agreement, without the consent of the TSP, for collateral security purposes to aid in providing financing for the Plant, provided that the Generator will require any secured party, trustee or mortgagee to notify the TSP of any such assignment. Any financing arrangement entered into by the Generator pursuant to this Section will provide that prior to or upon the exercise of the secured party's, trustee's or mortgagee's assignment rights pursuant to said arrangement, the secured creditor, the trustee or mortgagee will notify the TSP of the date and particulars of any such exercise of assignment right(s). Any attempted assignment that violates this Section is void and ineffective. Any assignment under this Agreement shall not relieve a Party of its obligations, nor shall a Party's obligations be enlarged, in whole or in part, by reason thereof. Where required, consent to assignment will not be unreasonably withheld, conditioned or delayed.

10.18 Severability. If any provision in this Agreement is finally determined to be invalid, void or unenforceable by any court having jurisdiction, such determination shall not invalidate, void or make unenforceable any other provision, agreement or covenant of this Agreement; provided that if the Generator (or any third-party, but only if such third-party is not acting at the direction of the TSP) seeks and obtains such a final determination with respect to any provision of Section 4.1.B, then none of the provisions of Section 4.1.B. shall thereafter have any force or effect and the Parties' rights and obligations shall be governed solely by Section 4.1.A.

10.19 Comparability. The Parties will comply with all applicable comparability and code of conduct laws, rules and regulations, as amended from time to time.

10.20 Invoicing and Payment. Unless the Parties otherwise agree (in a manner permitted by applicable PUCT Rules and as specified in writing in an Exhibit “E” attached hereto), invoicing and payment rights and obligations under this Agreement shall be governed by PUCT Rules or applicable Governmental Authority. Invoices shall be rendered to the paying Party at the address specified on, and payments shall be made in accordance with the requirements of, Exhibit “D.”

10.21 Confidentiality.

A. Subject to the exception in Section 10.21.B, any information that a Party claims is competitively sensitive, commercial or financial information under this Agreement (“Confidential Information”) shall not be disclosed by the other Party to any person not employed or retained by the other Party, except to the extent disclosure is (i) required by law; (ii) reasonably deemed by the disclosing Party to be required to be disclosed in connection with a dispute between or among the Parties, or the defense of litigation or dispute; (iii) otherwise permitted by consent of the other Party, such consent not to be unreasonably withheld; or (iv) necessary to fulfill its obligations under this Agreement or as a transmission service provider or a Control Area operator including disclosing the Confidential Information to the ISO. The Party asserting confidentiality shall notify the other Party in writing of the information it claims is confidential. Prior to any disclosures of the other Party’s Confidential Information under this subsection, or if any third party or Governmental Authority makes any request or demand for any of the information described in this subsection, the disclosing Party agrees to promptly notify the

CenterPoint Energy Contract #INT-20-197A

other Party in writing and agrees to assert confidentiality and cooperate with the other Party in seeking to protect the Confidential Information from public disclosure by confidentiality agreement, protective order or other reasonable measures.

B. This provision shall not apply to any information that was or is hereafter in the public domain (except as a result of a breach of this provision).

**Exhibit “B”  
Time Schedule**

1. Interconnection Option chosen by Generator (check one):

  X   Section 4.1.A. or        Section 4.1.B

If Section 4.1.B is chosen by Generator, the In-Service Date(s) was determined by (check one):  
(1)   N/A   good faith negotiations, or (2)   N/A   designated by Generator upon failure to agree.

2. Generator must deliver each of the following items (collectively, the “Prerequisite Items”) to TSP by no later than September 1, 2020 (the “Scheduled Start Date”):

The Notice to Proceed defined in Section 4.3.D of Exhibit “A”;

The CIAC, if any, described in Exhibit “C”; and

The Security described in Exhibit “E.”

The TIF In-Service Date is the later of January 1, 2022 or 15 months after TSP’s receipt of the Prerequisite Items.

The scheduled Commercial Operation Date is the later of April 1, 2022 or 3 months after the In-Service Date.

The Parties may change the dates and times in this Exhibit B in accordance with Section 4.5 of Exhibit “A.”

**Exhibit “C”**  
**Interconnection Details**

- 1) Plant Name: Sbranch Solar Project (“Plant”).
- 2) Point of Interconnection Location
  - A) TSP system side of Plant’s terminating structure inside Generator’s GIFSUB, located near County Road 207, Wharton County, Texas.
- 3) Delivery Voltage: 138 kV
- 4) Number and Size of Generating Unit(s)
  - A) Plant will be comprised of one (1) generator with a total net rating of 154 MW (“Planned Capacity”), which is projected to be the Plant’s Net Dependable Capability, as defined by ERCOT Requirements.
- 5) Type of Generating Unit
  - A) The Generating Unit is an inverter-based photovoltaic (PV) generation facility.
  - B) 54, Sungrow SG3150U photovoltaic inverters rated at approximately 3.15 MW each. The plant has its own 34.5 - 138 kV step-up (main power) transformer, with the 34.5 kV winding connected to plant auxiliary transformers as well as the units 34.5 kV collection bus through a 138 kV HV breaker.

<b>Solar PV Inverters</b>				
Description	Manufacturer	Rating (@113°F)	MPT Transformer Voltages	
54 PV inverters	Sungrow	170.1 MVA	34.5-138 kV	Solar PV
Total nominal gross MW:		154 MW		

- C) Each step-up, standby and auxiliary transformer connected at Delivery Voltage will have a circuit breaker for isolation from the TIF.
  - D) Electrical characteristics of Plant’s generating units shall be in accordance with the most recent version of data that Generator has provided to TSP and shall be consistent with data provided to ERCOT.
- 6) Metering Equipment
  - A) TSP shall provide and install ERCOT Polled Settlement (EPS) primary and check meters, 138 kV instrument transformers and associated wiring required for measuring the output of the Plant’s generation and auxiliary electrical load at TSP’s TIFSUB Substation. The 138 kV metering instrument transformers for the EPS metering shall be procured by TSP and owned, maintained, and replaced by TSP. TSP shall install and maintain the metering system’s components in a manner consistent with ERCOT Requirements and the PUCT Substantive Rules.
- 7) Generator Interconnection Facilities (GIF)

- A) Generator shall furnish, operate, and maintain a complete generation facility capable of generating the Planned Capacity, including, as applicable, but not limited to, all generators, power system stabilizers, generator step-up transformers, protective devices, and other transformers and associated foundations, the terminating structures, all relays necessary for the protection, synchronization and coordination of the generators, generator auxiliary equipment and the disconnect switches and foundations at the Point of Interconnection.
- B) The generation unit(s) shall meet all voltage and reactive requirements as outlined in the ERCOT Protocols, ERCOT Operating Guides and ERCOT Other Binding Documents.
- C) Generator shall furnish, own and maintain the connection from Plant's equipment to Plant's terminating structure at the Point of Interconnection, including phase conductors, static conductors, structure(s), tower fittings, suspension insulators, terminating clamps and line conductor terminal fittings.
- D) TSP shall provide to Generator the TSP's alpha/numeric identifiers for incoming 138 kV transmission lines and shall provide TSP's alpha/numeric identifiers for high voltage circuit breakers, switches, power transformers, generators and certain low side equipment and the TSP's assigned 6-character substation identification for the GIF. The GIF high voltage circuit breakers, switches, transformers, generators and certain low side equipment, including 34.5kV feeder breakers, shall be identified with TSP's identifiers. TSP will develop a substation basic one-line diagram that includes these identifiers. The Generator shall mark these identifiers on the substation equipment. TSP may stencil identification numbers on substation equipment and mount signs, labels, drawings, telephone numbers, and instructions on the GIF. The Generator shall use TSP's assigned substation name, or Substation ID, and equipment identifiers in discussions with TSP and in RARF submittals.
- E) Generator shall provide the foundations for Plant's terminating structures and disconnecting devices. Generator shall design and install the Plant's terminating structure(s), and disconnecting devices in accordance with TSP's conductor loading requirements.
- F) Generator shall connect its generating Plant ground mat to TSP's transmission tower static wires at the Plant's terminating structures. Static wire(s) shall be bonded directly to the generating plant's ground mat via use of dedicated grounding conductor(s) of adequate ampacity to establish main electrical bond(s).
- G) Electrical characteristics of Plant's Generator Interconnection Facilities shall be in accordance with the most recent version of TSP's "Specification for Customer 138 kV Substation Design" attached as Exhibit "I" and in particular, the section pertaining to "Generation".
- H) Generator shall provide a disconnect switch located on Generator's terminating structure(s) for connection to TSP's System.
- I) Generator shall provide NEMA four-hole pads on Plant's disconnect switch for connection to NEMA four-hole pads on TSP's connecting conductors.
- J) Generator shall grant to TSP all necessary land rights, in a form acceptable to and drafted by TSP.
- K) If control cable is utilized between the GIF and TIF, then Generator shall provide and maintain one or more duct banks (cable trenches) for communication, instrumentation, and control, and protective relaying circuits ("Control Duct Bank") to a Generator provided common manhole or handhole intersection point at the property interface with

TIFSUB Substation, as shown on the TIFSUB Substation Development Plan, identified below.

- L) Generator shall own all protective relays, instrument transformers, instrumentation, and control equipment physically located on Plant side of the Points of Interconnection.
- 8) TSP Interconnection Facilities (TIF)
- A) Generator shall facilitate conveyance to TSP, and TSP shall purchase, fee title to the property for the TIFSUB Substation located in Wharton County at an agreed price that shall not be greater than the market price as determined by an independent appraisal, the cost of said appraisal shall be split evenly between Generator and TSP. TSP shall subsequently construct the TIFSUB Substation on real property at the location shown in Exhibit "H".
  - B) TSP shall complete its entire scope of work on the TIFSUB Substation (except for Punch List Items) including, but not limited to, bus works, supports, structures, circuit breakers, disconnect switches, relays, and other equipment necessary for protection and coordination, controls, and wiring all as necessary to provide an interconnection between Plant's generation facilities and TSP's System; energize the same, and interconnect with Plant, all as provided herein.
    - 1) Punch List Items are defined as those non-material items of work that remain to be performed in order to ensure full compliance with this Agreement. Punch List Items do not include any items of work, alone or in the aggregate, non-completion of which (i) prevents the TIFSUB Substation from being used for its intended purposes as described in this Agreement or in accordance with applicable laws; (ii) prevents the TIFSUB Substation from being legally, safely, and reliably placed in commercial operation; or (iii) in the exercise of reasonable engineering judgment could have an adverse effect on the operation, efficiency, or reliability of the TIFSUB Substation, or its ability to transmit the Plant's power to the ERCOT grid.
  - C) TSP shall furnish, own, and maintain the connection from TSP's equipment to Plant's terminating structure(s) at the Point of Interconnection, including phase conductors, static conductors, structures, tower fittings, suspension insulators, terminating clamps and line conductor terminal fittings with NEMA standard four-hole flat pads for attachment to the NEMA four-hole pads on Plant's disconnecting device.
  - D) TSP shall furnish, own, and maintain the connection from TIFSUB Substation to TSP's transmission system.
  - E) TSP shall develop and install transmission improvements that it determines, in its sole discretion, are foreseeable and reasonably necessary to safely, reliably, and economically integrate the Plant into the TSP System. TSP IS SIZING THE INTERCONNECTION TO ACCOMMODATE THE PLANNED CAPACITY, HOWEVER TSP MAKES NO PROMISE, REPRESENTATION, OR WARRANTY AS TO WHETHER THE TSP SYSTEM WILL BE FREE OF CONSTRAINTS AT ANY TIME, INCLUDING BUT NOT LIMITED TO TIMES WHEN THE TRANSMISSION IMPROVEMENTS UNDER THIS AGREEMENT ARE BEING MADE OR AFTER THEIR COMPLETION.
  - F) TSP shall construct the TIFSUB Substation as shown on the drawing entitled "CenterPoint Energy 138 kV Development Plan for Inverter Field/Sandy Branch Solar Facility Study Basic Offer," dated 02-04-2020 ("TIFSUB Substation Development Plan")



and any subsequent modifications to such drawing(s) made by TSP and delivered to Generator.

- G) Generator shall facilitate to TSP all necessary land rights, in a form acceptable to and drafted by TSP.
- H) If copper protection or control cable is utilized between the GIF and TIF, then TSP shall provide a duct bank or cable trench, as mutually agreeable, for communication, instrumentation, and control, and protective relaying circuits (“Control Cable Raceway”) to a common manhole, provided by Generator, located at the property interface with Plant, as shown on the TIFSUB Substation Development Plan, identified above.

#### 9) Communications Facilities

- A) TSP shall provide and maintain, at TSP’s expense, a communication circuit for real-time data transmittal via SCADA equipment from the TIFSUB Substation to TSP’s Energy Management System.
- B) Generator shall provide a fiber optic communication interface device on its end of the fiber and TSP will provide a fiber optic communication interface device on its end of the fiber associated with the RTU inputs between Plant and the TIFSUB Substation.
- C) Generator shall furnish RTU inputs identified in Exhibit “C”, Paragraph 11)D) from the Plant to the TIFSUB Substation’s communication interface point.
- D) Generator shall provide a voice telephone extension outlet in close proximity to Plant’s relay panel that is located within the Plant. Such telephone extension outlet shall be connected to the local exchange carrier’s telephone system; however, the telephone extension outlet may be connected to Plant’s internal telephone system, provided Plant’s internal telephone system is equipped with an uninterruptible power supply system.
- E) TSP shall furnish RTU inputs identified in Exhibit “C”, Paragraph 11)E) from TIFSUB Substation to Plant’s communication interface termination point.
- F) TSP shall provide fiber optic communication cables of sufficient length to connect between Plant to the TIFSUB Substation relay panel.

#### 10) System Protection Equipment

- A) Generator shall provide two sets of protective relaying accuracy (C800) current transformers on Generator’s 138 kV circuit breakers associated with the protective relaying between Plant and the TIFSUB Substation. Each set of current transformers will provide signals to independent sets of primary and backup protective relays for the interconnecting lead between the GIF and the TIFSUB Substation. The current transformer ratio will be approved by the TSP relay protection engineer and reflected on the Generator’s drawings.
- B) The fiber optic communication cables will have strands of single mode fiber optic cable to be utilized at 1300 nm wavelength for communication of protection data and telemetry.

#### 11) Telemetry Requirements

- A) TSP shall furnish a substation SCADA RTU at the TIFSUB Substation. The RTU will be multi-port equipped and operate with protocols compatible with TSP. The RTU will be equipped to monitor the TIFSUB Substation as outlined in Paragraph 11 and control circuit breakers in the TIFSUB Substation. TSP shall also furnish the RTU inputs, such as contacts and transducers, in the TIFSUB Substation. Selected real-time data of the TIFSUB Substation will be available at TSP’s RTU for Generator’s use. TSP’s RTU will

be equipped with a DNP-3 “Slave” serial communication port for this purpose. TSP shall furnish the fiber optic cable(s) between the TIFSUB Substation and the Plant RTU or DCS “Master” serial communication port for this purpose.

- B) Generator shall furnish Plant data to TSP’s RTU communication port at the TIFSUB Substation as referenced below. The Generator’s RTU/DCS shall be equipped with a DNP-3 “Slave” serial communication port for this purpose. TSP shall furnish the fiber optic cable between the Plant and the TIFSUB Substation RTU “Master” serial communication port for this purpose.
- C) Generator shall provide Plant data to ERCOT according to ERCOT requirements. TSP is not responsible for providing Plant data to ERCOT.
- D) Generator shall provide to TSP at TSP’s TIFSUB Substation the following signals originating at Generator’s Plant:
  - 1) Analog Data from Plant
    - (i) Kilovolts for each collector bus (single line-to-line value).
    - (ii) Net megawatts for each generator feeder (three phase).
    - (iii) Net megavars for each generator feeder (three phase).
    - (iv) Net megavars for the reactive support equipment.
    - (v) Kilovolts for 138 kV transmission voltage (A phase).
    - (vi) Net megawatts and megavars for the 138 kV transmission line (three phase).
    - (vii) Frequency at the collector bus
    - (viii) Megawatts and megavars for each 138/{34.5} kV transformer (three phase).
  - 2) Status Data from Plant
    - (i) Status of the 138 kV transmission voltage circuit breakers.
    - (ii) Status of all 34.5 kV circuit breakers for feeders and reactive support equipment.
    - (iii) Status of generator automatic voltage regulator (automatic and manual).
- E) TSP will provide to Generator at Generator’s {GIFSUB}\_ Substation the following signals originating at TSP’s {TIFSUB}\_ Substation:
  - 1) Analog Data from TSP Substation Devices
    - (i) Kilovolts for the Point of Interconnection (A phase).
    - (ii) Megawatts, megavars, and megawatt-hour data.
  - 2) Data from TSP Substation Devices
    - (i) Status of transmission voltage circuit breakers associated with the generator lead(s).
    - (ii) Alarm for failure of Pilot Wire/fiber optic relaying communication channels, if applicable.

## 12) Supplemental Terms and Conditions

- A) The following drawings are attached and made a part of this agreement as Exhibit “H” – Attached Drawings. (*Note: The drawings contain a line of demarcation between TSP provided facilities and Generator provided facilities.*)
  - 1) CenterPoint Energy \_\_\_\_ 138 kV Development Plan for Inverter Field/Sandy Branch Solar Facility Study Basic Offer, dated 02-04-2020.
  - 2) Basic Offer – 138 kV One-Line Relaying and Metering Diagram for Inverter Field Solar Generation Facility Project Facility Study dated 02-04-2020.

## B) Cost Responsibility:

- 1) Notwithstanding the provisions of Exhibit "A", Section 8.1, the amount of the contribution in aid of construction, if any, that Generator may be required to make, shall be specified in Exhibit "E", Security Arrangement Details.
  - 2) The Generator does not desire any enhancements to TSP's basic offer interconnection facilities and therefore no contribution in aid of construction ("CIAC") of the Transmission Interconnection Facilities is required.
  - 3) The TIF described herein is designed based on the generating capacity provided by the Generator. It is assumed that the generating facility will be capable of generating the Planned Capacity by the Scheduled Commercial Operation Date specified in Exhibit "B". Within the first 12 months following Commercial Operation, if the highest level of Actual Capacity is less than the Planned Capacity, the Generator shall be responsible for TIF costs, if any, that are determined, solely by the TSP, to have been incurred to accommodate Generator's Planned Capacity, but are then determined to not be necessary to accommodate Generator's Actual Capacity. As used here, "Actual Capacity" shall mean the Plant's total Net Dependable Capability, as determined or accepted by ERCOT, in accordance with ERCOT Requirements. Generator shall pay such costs determined herein within thirty (30) days following the receipt of TSP's invoice.
- C) Authorization to Proceed:
- 1) Generator authorizes TSP to begin work on any required transmission system additions, modifications, and upgrades and the TIFSUB Substation additions, modifications, and upgrades secured by this agreement [ *except that, TSP will not, without prior written approval from Generator, incur any costs and expenses in excess of \$ \_\_\_\_\_; and*
  - 2) (i) *until released to do so by Generator. Such release shall be provided in the form of a Notice to Proceed.*
- D) Clarifications to Exhibit "A"
- 1) The Parties agree that at the time of executing this Agreement the references to the PUCT Rules contained within certain definitions set forth in Exhibit "A", "Article 1. Definitions" have the meanings ascribed to such terms as established in the current PUCT Rules. The Parties recognize that the PUCT Rules are amended from time to time by the PUCT. The parties also acknowledge that ERCOT issues ERCOT Requirements in which terms are redefined from time to time. When the PUCT Rules or ERCOT Requirements are amended and terms defined in Exhibit "A", "Article 1. Definitions" are affected by such amendments, the Parties agree that such terms shall have the meanings as amended by the PUCT or ERCOT. The term "System Security Study" shall have the same definition as "Security Screening Study" in the ERCOT Requirements.
- E) Miscellaneous
- 1) Each Party shall be solely responsible for keeping itself informed of, and understanding its respective responsibilities under, all applicable North American Electric Reliability Corporation ("NERC") Standards and ERCOT Requirements and all valid, applicable laws, rules, regulations and orders of, and tariffs approved by, duly constituted Governmental Authorities.
  - 2) CenterPoint Energy has documented data specifications that define the operational data CenterPoint Energy requires to perform real-time monitoring. These

specifications are incorporated in Section 11 above, Exhibit 'F' Outage and Clearance Coordination Procedure, and Exhibit 'G' Telemetry Specification.

- 3) Generator shall provide on its property access roads to the TIF, and the access roads will be maintained by Generator in such a manner and condition to allow passage of heavy utility vehicles. Otherwise, Generator shall provide, or cause to be provided, such perpetual easements as reasonably needed by TSP, in a form acceptable to TSP and at no cost to TSP, to use and construct access roads from County Road 207 to the TIF in such a manner and condition to allow passage of heavy utility vehicles.
  - 4) Each Party's personnel, contractors, subcontractors, and agents shall abide by and comply with the other Party's reasonable safety requirements and procedures while in areas designated as under that other Party's control.
  - 5) In the event that Generator's personnel, contractors, subcontractors, or agents cause delays in the work schedule of TSP, Generator shall reimburse to TSP the additional costs associated with such delays within 30 days of receipt of an invoice for such costs.
  - 6) Generator understands and agrees that identification of any, including but not limited to stability, oscillation, harmonic, short circuit, over frequency, under frequency, over voltage, under voltage, phase imbalance, or geomagnetic disturbance conditions that may affect Generator's Plant on Generator's side of the Point of Interconnection and implementation of any associated protective measures, are the sole responsibility of Generator.
  - 7) ERCOT Requirements.
    - (i) Unless expressly stated herein, where the ERCOT Requirements are in conflict with TSP's specifications or procedures, the ERCOT Requirements shall prevail.
    - (ii) ERCOT requirements currently require installation of power system stabilizers on generators.
    - (iii) Prior to commercial operation, ERCOT may verify that the Generator is meeting ERCOT Requirements, including complying with Guide and Protocol requirements on RARF modeling, telemetry and testing, as well as complying with reactive standards, the provision of accurate stability models, and the installation of power system stabilizers, if required. It should be noted that the Generator will not be able to energize the GIF until authorized by ERCOT (typically 30 days after the TIF is modeled and energized). Failure to meet these ERCOT Requirements may result in delays to commercial operation.
  - 8) All generator data, including data for stability studies (transient and voltage) and subsynchronous resonance data, as required by the ERCOT Requirements, shall be provided to ERCOT and the TSP before commercial operation. This data shall be updated when the Plant begins commercial operation. Any updates to this information will be provided within 60 days to ERCOT and the TSP as changes or upgrades are made during the life of the Plant. This requirement applies to all future owners of the Plant. The Generator and any future owners of the Plant shall comply with these data requirements along with all applicable NERC Standards. Such Standards are subject to change from time to time, and such changes shall automatically become applicable based upon the effective date of the approved change.
- 13) Special Operating Conditions, if any, attached: None.

14) Cost Estimate Differences, if applicable:

- A) The difference between the estimated cost of the TIF under 4.1.A (\$ N/A ) and the estimated cost of the TIF under 4.1.B (\$ N/A ) is: N/A, if applicable.

**Exhibit "D"****Notice and EFT Information of the ERCOT Standard Generation Interconnection Agreement**

(a) All notices of an operational nature shall be in writing and/or may be sent between the Parties via electronic means including facsimile as follows:	
If to  CG Wharton County LLC Attn: Ty White 1001 McKinney Street, Suite 700 Houston, TX 77002 24 Hour Telephone (936) 355-4728 Operational/Confirmation Fax (346) 998-2021 E-mail <a href="mailto:contractadmin@connectgenllc.com">contractadmin@connectgenllc.com</a>	If to CenterPoint Energy Houston Electric, LLC  CenterPoint Energy Houston Electric, LLC Attn: Real Time Operations P.O. Box 1700 Houston, Texas 77251 24 Hour Telephone (713) 894-0491 Operational/Confirmation Fax (713) 207-2349
(b) Notices of an administrative nature:	
If to  CG Wharton County LLC Attn: General Counsel 1001 McKinney Street, Suite 700 Houston, TX 77002 Phone: (346) 998-2031 Fax: (346) 998-2021 E-mail: <a href="mailto:slegrand@connectgenllc.com">slegrand@connectgenllc.com</a>	If to CenterPoint Energy Houston Electric, LLC  CenterPoint Energy Houston Electric, LLC Attn: Manager, Transmission Accounts P.O. Box 1700 Houston, Texas 77251 Phone: (713) 207-7617 Fax: (713) 207-9122 E-mail: <a href="mailto:lesli.cummings@centerpointenergy.com">lesli.cummings@centerpointenergy.com</a>
(c) Notice for statement and billing purposes:	
If to  CG Wharton County LLC Attn: Accounts Payable 1001 McKinney Street, Suite 700 Houston, TX 77002 Phone: (346) 998-2033 E-mail: <a href="mailto:ap@connectgenllc.com">ap@connectgenllc.com</a>	If to CenterPoint Energy Houston Electric, LLC  Accounts Payable P.O. Box 1374 Houston, Texas 77251 Phone: (713) 207-7888 Fax: (713) 207-9986 E-mail: <a href="mailto:AP.invoices@centerpointenergy.com">AP.invoices@centerpointenergy.com</a>
(d) Information concerning electronic funds transfers:	
If to CG Wharton County LLC  Cadence Bank Houston, TX ABA No. 062206295 _____ for credit to: CG Wharton County LLC Account No. 5500190268	If to CenterPoint Energy Houston Electric, LLC  Chase Bank of Texas Houston, Texas ABA No. _111000614 _____ for credit to: CenterPoint Energy Houston Electric, LLC Account No. 0010-097-0798

**Exhibit "E"**  
**Security Arrangement Details**

- A) The total estimated project cost to construct the TIF as described in Exhibit "C" (less any CIAC amount described in Exhibit C) is approximately \$9,892,000.00 (the "Security Estimate"). The Security Estimate does not include the estimated cost for obtaining any required CCNs for the TIF. The Parties at this time do not anticipate that a CCN is required for the construction of the TIF. However, if TSP determines that a CCN is required to construct the TIF or any portion thereof, the estimated cost for obtaining the CCN will be added to the Security Estimate (with such addition, the "Revised Security Estimate").
- B) In accordance with Section 8.3 of Exhibit A, TSP requires Generator to deliver the Security in the form described below in the amount of the Security Estimate or Revised Security Estimate by the Scheduled Start Date specified in Exhibit "B."

**[LETTER OF CREDIT OPTION]**

- C) Generator shall provide the Security in the form of an irrevocable letter of credit in favor of TSP issued by a financial institution reasonably acceptable to TSP having a long-term debt rating by Moody's Investor Services of "A3" or better, and Standard & Poor's long-term debt rating of "A-" or better.

**[CASH DEPOSIT OPTION]**

3. Generator shall provide the Security in the form of a cash deposit in U.S. dollars by wire transfer or other mutually agreeable method, to TSP.

**Exhibit "F"**  
**Outage and Clearance Coordination Procedures**

File Description	File
Outage and Clearance Coordination Procedures	 2017 T&S Outage and Clearance Coordination Procedures





# Transmission & Substation Outage and Clearance Coordination Procedures

Real Time Operations Department

Revised August 21, 2017



<b>CENTERPOINT ENERGY TELEPHONE NUMBERS .....</b>	<b>3</b>
<b>1 INTRODUCTION .....</b>	<b>4</b>
1.1 APPLICABILITY .....	4
1.2 PURPOSE .....	4
1.3 COPIES OF THIS PROCEDURE .....	4
1.4 FACILITY OWNERSHIP OR NAME CHANGE.....	4
1.5 PROCEDURE CONFLICTS.....	4
1.6 EQUIPMENT CHANGES .....	4
1.7 GENERATION INSTALLATION AND OPERATION.....	5
1.8 POWER FACTOR.....	5
1.9 VOLTAGE FLUCTUATIONS .....	5
1.10 EMERGENCY RESPONSE .....	5
1.11 UNPLANNED OUTAGE RESTORATION .....	5
<b>2 CNP ACCESS TO THE CUSTOMER’S FACILITIES .....</b>	<b>7</b>
2.1 AUTHORIZED REPRESENTATIVE OF CNP .....	7
<b>3 COMMUNICATIONS WITH CNP .....</b>	<b>8</b>
3.1 REAL TIME OPERATIONS DEPARTMENT .....	8
3.2 SCHEDULING TRANSMISSION EQUIPMENT OUTAGES .....	8
3.3 TRANSMISSION ACCOUNTS DIVISION .....	9
3.4 SUBSTATION AND EQUIPMENT IDENTIFICATION .....	9
3.5 TELEPHONE LINES AND DATA COMMUNICATION .....	10
3.6 ALARM RESPONSE.....	10
3.7 OUTAGE SCHEDULING REQUIREMENTS .....	11
3.8 CYBER SECURITY INCIDENT.....	12
<b>4 SWITCHING, CLEARANCES, GROUNDING.....</b>	<b>13</b>
4.1 BILLABLE COSTS .....	13
4.2 SWITCHING .....	13
4.3 CLEARANCES .....	14
4.4 GROUNDING.....	14
4.5 SWITCHING 345 KV FACILITIES EQUIPPED WITH FERRORESONANCE PROTECTION..	15
4.6 TERMINOLOGY FOR SWITCHING ORDERS.....	16
4.7 SWITCHING ORDER .....	17
4.8 TRANSMISSION SWITCHING CHECK LIST.....	18
<b>5 OUTAGE SCHEDULING CHECK LIST .....</b>	<b>19</b>
5.1 OUTAGE SCHEDULING CHECK LIST .....	19
<b>6 UNPLANNED OUTAGES.....</b>	<b>20</b>
6.1 UNPLANNED OUTAGES .....	20
6.2 UNPLANNED OUTAGES OF 345 KV FACILITIES EQUIPPED WITH FERRORESONANCE PROTECTION.....	20
6.3 EMERGENCY SWITCHING .....	21



6.4	EMERGENCY SWITCHING CHECK LIST .....	22
6.5	OTHER EMERGENCY CONDITIONS .....	22
7	GENERATION OPERATION .....	23
7.1	APPLICABILITY .....	23
7.2	UNIT OPERATION.....	23
8	PROTECTIVE RELAYING AND CONTROL.....	24
8.1	SETTINGS FOR RELAYS INSTALLED FOR THE PROTECTION AND AUTOMATIC RECLOSING OF CNP TRANSMISSION LINES.....	24
8.2	APPLICABLE RELAY SETTINGS.....	24
8.3	COMMUNICATIONS CONNECTIONS TO ELECTRONIC DEVICES .....	24
8.4	MAINTAINING LEVELS OF PROTECTION.....	24
9	EQUIPMENT ADDITIONS, REPLACEMENT, UPGRADES AND REMOVAL .....	25
9.1	EQUIPMENT CHANGES .....	25
9.2	MODIFICATION, REPAIR, AND REPLACEMENT OF CUSTOMER EQUIPMENT .....	25
9.3	CUSTOMER SUBSTATION EQUIPMENT ADDITIONS, RELOCATIONS, UPGRADES AND/OR REMOVALS.....	26
10	EQUIPMENT MAINTENANCE AND TESTING .....	27
10.1	CNP TESTING .....	27
10.2	CUSTOMER MAINTENANCE AND TESTING .....	27
10.3	MONTHLY INSPECTIONS .....	27
10.4	QUARTERLY, SEMI-ANNUAL TESTING, AND INSPECTION .....	28
10.5	DC BATTERY SYSTEM .....	28
10.6	FUNCTIONAL TESTING.....	28
10.7	SPECIAL INSPECTION AND TESTING .....	28
11	PLANT DESIGN CONSIDERATIONS.....	30
11.1	EMERGENCY SYSTEMS .....	30
11.2	AUTOMATIC RECLOSING .....	30
11.3	SYSTEM VOLTAGE.....	30
11.4	ELECTRICAL PROTECTION COORDINATION STUDIES.....	30
11.5	SUBSTATION DESIGN SPECIFICATIONS .....	30



# CenterPoint Energy Telephone Numbers

## Real Time Operations Department (RTO)

RTO System Controller	281-894-0491 (24 hours)
RTO HOTLINE (Emergency)	281-894-1625 (24 hours)

## Outage Scheduling:

Submit request to: [OutageRequest@centerpointenergy.com](mailto:OutageRequest@centerpointenergy.com)

Outage Questions call 713/207-2714 (Primary) or 713-207-2196

## Metering Department:

High Voltage Metering	713-945-6689
Metering Engineering	713-207-4155

## Transmission Accounts Representatives:

Nicholas Carroll	713-207-2785
Greg DonCarlos	713-207-3512
Tim Raines	713-207-3538
Kevin Sarvis	713-207-5639
Joe (Cliff) Teaster	713-207-2263



# 1 Introduction

## 1.1 Applicability

1.1.1 This procedure applies to entities (“the Customers”) who own high voltage transmission and/or generation facilities interconnected to CenterPoint Energy Houston Electric, LLC’s (“CNP”) 69 kV, 138 kV, or 345 kV transmission system. Customer, as used in this document, includes the Customer’s authorized contractors or agents. The Customer shall ensure that the provisions in this document are applied to facilities that may be owned by others and that are interconnected to the Customer’s facility at the same voltage at which the Customer’s facility is interconnected to CNP’s transmission system.

## 1.2 Purpose

1.2.1 The purpose of this document is to facilitate the coordinated operation, outage coordination, maintenance, design, and modification of the Customer’s high voltage transmission or generation facilities with CNP facilities.

## 1.3 Copies of This Procedure

1.3.1 The Customer shall keep copies of this procedure in applicable Customer substation control houses and plant operating centers. This procedure, including forms, may be reproduced.

## 1.4 Facility Ownership or Name Change

1.4.1 The Customer shall inform CNP of any change in ownership or name of their interconnected facilities or facilities owned by others that are interconnected to their facilities.

## 1.5 Procedure Conflicts

1.5.1 Any conflicts between this procedure and the Customer’s procedures shall be thoroughly discussed with appropriate CNP representatives and resolved before beginning any work.

## 1.6 Equipment Changes

1.6.1 The Customer shall provide all equipment, in accordance with CNP specifications, whenever changes in CNP transmission system, including monitoring and protection devices, require changes in the Customer’s interconnected facilities to maintain compatibility.

1.6.2 The Customer shall provide sufficient notice to CNP of any proposed changes to their facilities as specified in Section 9 (Equipment Additions, Replacement, Upgrades and Removal) of this document. This notification shall include providing necessary details, so that CNP can provide comments based upon a general, functional review. The Customer shall not procure any equipment



or materials or begin any work until all CNP comments are incorporated or resolved.

## 1.7 Generation Installation and Operation

1.7.1 Customers desiring to connect generation that will operate in parallel to CNP's transmission system shall file an application with the Electric Reliability Council of Texas ("ERCOT") requesting interconnection in accordance with ERCOT's Generation Interconnection Procedure.

1.7.2 The Customer's generation facility shall be operated in accordance with the ERCOT Protocols and Operating Guides available at:

<http://www.ercot.com/mktrules/nprotocols>

<http://www.ercot.com/mktrules/guides/noperating/cur>

## 1.8 Power Factor

1.8.1 The Customer shall provide suitable apparatus to maintain power factor consistent with the requirements of CNP's Tariff for Retail Delivery Service.

## 1.9 Voltage Fluctuations

1.9.1 The Customer shall provide suitable apparatus to mitigate voltage fluctuations to reasonable limits should the Customer's equipment cause voltage fluctuations that interfere with CNP's transmission system.

## 1.10 Emergency Response

1.10.1 In an emergency, the Customer shall switch substation equipment, reduce MW output, change reactive output, or perform other measures as directed by ERCOT or CNP's Real Time Operations Department ("RTO"), to help alleviate the emergency.

1.10.2 CNP may interrupt transmission service to and deliveries from the Customer in the event of an emergency.

## 1.11 Unplanned Outage Restoration

1.11.1 Customer substations are an integral part of the interconnected transmission system, and CNP personnel may need to perform switching activities in a Customer substation to restore service to other customers in a timely manner. Customer actions that delay such switching activities can result in economic and/or environmental impacts for neighboring customers and pricing impacts for electricity market participants.

1.11.2 The Customer shall follow the applicable provisions as specified in Section 6 (Unplanned Outages) of this document.

1.11.3 Following evaluation of available information, the RTO System Controller shall issue switching orders to restore CNP transmission lines. Available information may include Customer reports, CNP field inspections of



transmission lines and substations, lightning data, digital fault recorder data, protective relay data, fault location analysis, and Traveling Wave System ("TWS") fault location.



## **2 CNP Access to the Customer's Facilities**

### **2.1 Authorized Representative of CNP**

2.1.1 An authorized representative of CNP shall have access to the Customer's premises for the purpose of performing switching orders, inspecting CNP's wiring and apparatus, repairing, erecting, removing, or replacing CNP-owned equipment, reading CNP meters, performing routine testing of certain Customer equipment, performing inspections of CNP apparatus and switching following an unplanned outage of CNP transmission lines, and for all other purposes related to the interconnection.





### **3 Communications with CNP**

#### **3.1 Real Time Operations Department**

3.1.1 RTO operates CNP's transmission system and coordinates the operation of interconnected high voltage facilities. RTO provides routine and emergency switching instructions, issues clearances, and dispatches CNP personnel in response to electrical outages and problems. The Customer shall schedule planned outages with RTO and obtain from RTO switching instructions for any equipment at the Customer's substation that is directly interconnected with CNP's transmission system. Switching in the Customer's facilities that are remote to the Customer's substation directly interconnected with CNP's transmission system does not need to be scheduled. CNP will notify the Customer one or more days in advance if switching is required in the Customer's substation for planned transmission line outages or if the Customer's substation will be placed in a single-ended condition.

#### **3.2 Scheduling Transmission Equipment Outages**

3.2.1 CNP's substation equipment outage scheduling and reporting requirements have been developed to support ERCOT requirements for scheduling outages on circuit breakers, bus sections, transmission lines, and transformers that have an operating voltage of 60 kV and higher and to support requirements for scheduling outages of ERCOT Polled-Settlement ("EPS") metering equipment.

3.2.2 The Customer shall contact the RTO Outage Scheduler as shown in Table 1 at the end of this section to coordinate outages in the substation that is directly interconnected with CNP's transmission system. Requests are considered in the order they are received.

3.2.3 Switching Orders, Clearances - The Customer shall follow switching instructions provided by the RTO System Controller prior to initiating any switching to remove equipment from service or return equipment to service in the Customer's facilities. The Customer shall request a clearance from the RTO System Controller when required. A "Switching Order" form and a "Transmission Switching Check List" form are included in this document. The RTO System Controller can be contacted at 281-894-0491.

3.2.4 Unplanned Outages, Emergencies - The Customer shall contact the RTO System Controller as soon as possible whenever any unplanned tripping of any circuit breaker operating at a voltage of 60 kV and higher occurs. An "Unplanned Outage Check List" form is included in this document. In the event of an unplanned generation outage, the Customer or his designated representative shall advise CNP's RTO System Controller as soon as possible. In emergency situations, switching may be performed by a qualified person, which is authorized by the Customer, based upon switching instructions provided by the RTO System Controller. An "Emergency Switching Check List" form is included in this document. The RTO System



Controller can be contacted at 281-894-0491 or at the RTO HOTLINE 281-894-1625.

3.2.5 ERCOT Approvals - The RTO System Scheduler will coordinate a review and notify the Customer whether the outage can be scheduled for the desired day. Transmission line outages and the energization of new equipment require the approval of ERCOT. The Customer shall notify the RTO System Scheduler as soon as possible if an outage is canceled prior to the outage date. The Customer shall immediately notify the RTO System Controller if an outage is canceled on the day of the outage. CNP endeavors to notify the Customer as soon as possible when it is deemed necessary to cancel an outage.

3.2.6 Customer Substation Evacuations – During emergencies requiring evacuation of the Customer’s facility, the Customer shall contact RTO prior to the evacuation and provide information regarding the operational status of their substation and associated support facilities, such as substation station service power, battery and battery charger, and ability for CNP to access the substation. The Customer’s substation is an integral part of the interconnected transmission system and disabling them has an impact on the electrical grid.

### 3.3 Transmission Accounts Division

3.3.1 CNP’s Transmission Accounts Division (“Transmission Accounts”) is responsible for coordinating the Customer’s service needs within CNP. Transmission Accounts representatives endeavor to inform the Customer of long range planned switching and projects that may affect the Customer’s facility.

3.3.2 The Customer shall notify the Transmission Accounts representative as specified in Section 9 (Equipment Additions, Replacement, Upgrades and Removal) when equipment additions or removals are planned or when high voltage equipment 60 kV and higher or associated equipment requires modification or replacement. The Customer shall contact a Transmission Accounts representative to request current CNP specifications and applicable bills of material for substation equipment additions and replacement.

3.3.3 Transmission Accounts representatives may be contacted for any questions concerning the operation of the Customer’s substation. The Transmission Accounts representatives are listed on the CenterPoint Energy Telephone Numbers page in this document.

### 3.4 Substation and Equipment Identification

3.4.1 CNP assigns a substation name, or a Substation ID of six characters or less, to identify the Customer’s substation facility. The Substation ID is also referred to as the six character mnemonic name in which some characters may be blank. CNP mounts signs with the substation name or the Substation



ID on a substation control house door and on a substation entrance gate at the Customer's facility.

3.4.2 The Customer's high voltage circuit breakers switches, transformers, and certain low side equipment shall be identified with CNP's assigned numbers. CNP develops a substation basic one-line diagram that includes these assigned numbers. CNP or the Customer shall mark these numbers on the substation equipment. CNP may stencil identification numbers on substation equipment and mount signs, labels, drawings, telephone numbers, and instructions on the Customer's facilities.

3.4.3 The Customer shall use CNP's assigned substation name, or Substation ID, and equipment identification numbers in discussions with the RTO System Controller and the RTO System Scheduler.

### 3.5 Telephone Lines and Data Communication

3.5.1 The customer is responsible for arrangements with the telephone service provider to establish a direct dial telephone land line to the customer substation control cubicle.

3.5.2 Refer to CenterPoint Energy 007-400-02 Specification for Remote Telemetry of a Customer-Owned Facility for details pertaining to required communications circuits (i.e., customer provided voice communication and CenterPoint Energy provided telemetry communications for SCADA, metering, etc.)

### 3.6 Alarm Response

3.6.1 CNP responds to alarms for communication equipment installed to protect CNP transmission circuits.

3.6.2 The Customer shall report substation alarms to the RTO System Controller and respond to alarms pertaining to their equipment. A protective relay "CPU Failure" alarm shall be immediately reported to the RTO System Controller. A "Loss of DC" alarm shall be immediately reported to the RTO System Controller and investigated by the customer.



### 3.7 Outage Scheduling Requirements

Per ERCOT and CNP outage reporting requirements: planned outages on circuit breakers, transmission lines, and autotransformers that are rated 60 kV and higher must be submitted to the ERCOT Outage Coordinator by the CNP RTO Outage Coordinator.

Per ERCOT Protocols, planned outages on ERCOT Polled Settlement (“EPS”) meters and the equipment to which they are connected require a 5 day minimum notice. A 10 calendar-day minimum notice is required for any modifications to approved EPS equipment.

**Table 1 Planned Outage Scheduling**

Equipment Being Requested	Minimum Advance Notice	Contact
69 kV and 138 kV lines, single load transformers, individual breakers and bus outages of no more than one day in duration.	No later than 1200 hours Wednesday two weeks before the Planned Outage is to take place.	Outage Scheduler @ 713-207-2196 or 713-207-2714
All transmission line outages and equipment outages, including busses, of up to four contiguous days duration (daily or continuous outages).	35 Calendar Days	Outage Scheduler @ 713-207-2196 or 713-207-2714
Any transmission line outages and/or equipment outages, including busses, of 5 days or longer duration (daily or continuous)	90 Calendar Days	Outage Scheduler @ 713-207-2196 or 713-207-2714

Amount of time between the request for approval of the proposed Outage and the scheduled start date of the proposed Outage:	ERCOT shall approve or reject no later than:
Three days	1800 hours, two days before the start of the proposed Outage
Between four and eight days	1800 hours, three days before the start of the proposed Outage
Between nine days and 45 days	Four days before the start of the proposed Outage
Between 46 and 90 days	30 days before the start of the proposed Outage
Greater than 90 days	75 days before the start of the proposed Outage



## **3.8 Cyber Security Incident**

- 3.8.1 A Cyber Security Incident is a malicious act or suspicious event that disrupts, or was an attempt to disrupt, the operation of a Bulk Electric System (BES) Cyber System. A SCADA remote terminal unit (RTU) is an example of a BES Cyber System.
- 3.8.2 If the Customer identifies a possible, or verified, Cyber Security Incident impacting the operation of a CNP-owned BES Cyber System, the Customer shall contact RTO as soon as practicable.



## 4 Switching, Clearances, Grounding

### 4.1 Billable Costs

- 4.1.1 Grounding and switching requested by the Customer to be performed during other than normal working hours is billable to the Customer.
- 4.1.2 Grounding and switching charges will be waived under the following conditions:
  - 4.1.2.1 The Customer requesting switching or grounding activities by CNP is a transmission voltage service customer that is interconnected to CNP's transmission system through a customer-owned substation; and
  - 4.1.2.2 The requested activities are to allow the Customer to perform maintenance activities or equipment upgrades on its transmission voltage facilities within the Customer's substation; and
  - 4.1.2.3 The switching and grounding field activities are requested to occur on a normal CNP work day, with outages commencing no earlier than 0800, and outages concluding no later than 1600.
- 4.1.3 Outages extending beyond the timeframes identified in Section 4.1.2.3 above (commencing no earlier than 0800 and concluding no later than 1600) on a forced basis may result in billing for associated switching and grounding activities, as determined on a case-by-case basis.
- 4.1.4 Outages with switching or grounding activities requested for more than two consecutive days may be subject to charges for each additional consecutive day, even if the outages occur within the timeframes identified in Section 4.1.2.3 above (commencing no earlier than 0800 and concluding no later than 1600), unless early or intermittent outage restoration is required by ERCOT or for CNP system requirements.
- 4.1.5 Questions regarding charges should be directed to the Transmission Accounts representative.

### 4.2 Switching

- 4.2.1 CNP performs necessary switching at the remote end of a CNP transmission line for outages at the Customer's substation that require switching of CNP transmission lines. CNP provides switching instructions for the high voltage devices in the Customer's substation that is directly interconnected with CNP's transmission system. Switching instructions are not provided for remote facilities interconnected to the Customer's substation that is directly interconnected with CNP's transmission system. A "Switching Order" form and a "Transmission Switching Check List" form are included in this document.



- 4.2.2 The Customer shall follow switching instructions provided by the RTO System Controller prior to initiating any switching to remove equipment from service or return equipment to service in the Customer's facilities. The Customer shall implement specific procedures for the switching of its facilities. These procedures shall include a visual check that all phases have fully opened or closed. A device bearing a Hold Tag shall not be operated under any circumstances.
- 4.2.3 The Customer shall provide a Hold Order to RTO for switching at generation facilities for equipment that interconnects with CNP.

#### 4.3 Clearances

- 4.3.1 A clearance is required for applicable work on high voltage apparatus connected to CNP transmission lines when switching at the remote end of a CNP transmission line is necessary. Clearances are also issued when the Customer and CNP will be working on apparatus within the same isolated area at the Customer's facilities. Each party will be issued an individual clearance.
- 4.3.2 A clearance is required for applicable work on high voltage apparatus connected to CNP transmission lines when switching at the remote end of a CNP transmission line is necessary. Clearances are also issued when the Customer and CNP will be working on apparatus within the same isolated area at the Customer's facilities. Each party will be issued an individual clearance.
- 4.3.3 The Customer shall request a clearance from the RTO System Controller when required. Personnel authorized by CNP will perform either "trip & hold" or "check for trip & hold" on necessary devices before a clearance will be issued.
- 4.3.4 A clearance cannot be released by anyone other than the person to whom it was issued unless uncontrollable circumstances make that impossible. In this situation, the person's supervisor may, after informing each member of the crew that such action is being taken, contact the RTO System Controller to release the clearance. For field personnel shift changes, the person assuming the leadership of the work will be issued a new clearance and the person to whom the clearance was originally issued will then release the clearance.

#### 4.4 Grounding

- 4.4.1 CNP issues clearances, as identified in Section 4.3.1 above, indicating that high voltage devices have been opened, locked, and tagged to prevent the devices from operating. After receiving a clearance from the RTO System Controller, if required, and verifying that the apparatus is de-energized, the Customer shall install protective grounds on all de-energized electrical



apparatus before applicable work is performed on it. The Customer shall not install protective grounds on CNP transmission lines or CNP equipment.

- 4.4.2 When more than one party (e.g., the Customer and CNP) will be working on apparatus within the same isolated area at the Customer's facilities, each party shall install their own individual grounds before applicable work is performed.
- 4.4.3 The Customer may perform work on the control circuits and mechanisms of a device without grounding the apparatus, if such work can be performed without risk of contact with primary voltages. Grounds may be temporarily removed if required by testing procedures.
- 4.4.4 Before a grounding device is attached to any Customer high voltage bus work, the Customer shall first test the bus work to confirm that it is de-energized. Grounds shall be placed such that the operation of a switching device cannot remove their protection.
- 4.4.5 The clamps and conductors of grounding devices used by the Customer shall be designed for the available fault current. Grounding devices shall be inspected for broken strands and loose connections. The surface of the ground clamps shall be clean of corrosion and oxides.
- 4.4.6 Grounding devices used by the Customer for high voltage bus work shall be installed and removed with the use of applicable live line tools. Grounding devices shall be securely connected at the ground end before connection is made to the Customer high voltage bus work. Grounds shall be removed by first detaching the connection at the conductor and, then, detaching the connection at the ground end. When grounding to a steel structure, the ground shall not be applied to a flat surface unless an appropriate flat surface clamp is used.
- 4.4.7 CNP does not ground Customer-owned substation equipment except for work being performed by CNP.

#### 4.5 Switching 345 kV Facilities Equipped with Ferroresonance Protection

- 4.5.1 Ferroresonance protection is installed whenever a wound potential transformer ("PT") is connected to 345 kV and the possibility of a ferroresonance condition occurring exists. If applicable, the Customer shall implement specific procedures for switching 345 kV equipment that has ferroresonance protection installed. Procedures shall include the following:
  - Place the sync handle in position for the last breaker that will be opened.
  - Monitor the three potential lights located on the control panel inside the control house before and after the last breaker is opened. If one or more of the lights do not dim immediately but gets brighter:
    - immediately close the last breaker opened to reenergize the bus
    - investigate the ferroresonance protection
  - If all lights dim immediately:





- reset the targets (flags) on the ferroresonance protection relays
- If relay targets did not operate:
  - investigate the ferroresonance protection circuit

#### 4.6 Terminology for Switching Orders

Time - Military time, or 24 hour clock, based on prevailing Central Time.

Check Ring for Close - Verify by visual inspection that all devices in the ring are in the closed position.

Remove / Roll Loads - Remove all loads connected to a power transformer. This may be done by tripping applicable low side breakers or by rolling load to an adjacent transformer and tripping applicable low side breakers.

Trip - Initiate and complete an opening operation on a device.

Close - Initiate and complete a closing operation on a device.

Hold Tag - A tag placed on a device to indicate the equipment shall not be allowed to change operating state. The tag shall indicate the party who placed the tag.

Trip and Hold - Trip device, physically or mechanically (e.g., affix padlock) disable device from closing, and place a Hold Tag on the device.

Check for Trip and Hold - Verify by visual inspection that a device is in the trip position and place a Hold Tag on the device.

Secure Against Operation (SAO) - Physically, mechanically, or electrically disable a device (e.g., a motor operated disconnect switch) to prevent it from operating.

Secondary Potential Fuse (SPF) - Remove and tag fuses on the secondary side of potential devices to prevent the possibility of back energizing isolated equipment.



### 4.7 Switching Order

#### SWITCHING

ORDER # \_\_\_\_\_

SUBSTATION \_\_\_\_\_

EQUIPMENT \_\_\_\_\_

**OUT**

**RESTORE**

DISP. \_\_\_\_\_ DISP. \_\_\_\_\_

TIME \_\_\_\_\_ TIME \_\_\_\_\_

DATE \_\_\_\_\_ DATE \_\_\_\_\_

EXEC. BY \_\_\_\_\_ EXEC. BY \_\_\_\_\_

TIME \_\_\_\_\_ TIME \_\_\_\_\_

CLEARANCE # \_\_\_\_\_

**ISSUED**

**RELEASED**

DISP. \_\_\_\_\_ DISP. \_\_\_\_\_

TIME \_\_\_\_\_ TIME \_\_\_\_\_

DATE \_\_\_\_\_ DATE \_\_\_\_\_

ISSUED TO \_\_\_\_\_

NUMBER OF MEN \_\_\_\_\_ AND GROUNDS \_\_\_\_\_

ON \_\_\_\_\_

\_\_\_\_\_

#### INSTRUCTIONS

\_\_\_\_\_  
\_\_\_\_\_  
\_\_\_\_\_  
\_\_\_\_\_  
\_\_\_\_\_  
\_\_\_\_\_  
\_\_\_\_\_  
\_\_\_\_\_  
\_\_\_\_\_  
\_\_\_\_\_  
\_\_\_\_\_  
\_\_\_\_\_  
\_\_\_\_\_  
\_\_\_\_\_  
\_\_\_\_\_  
\_\_\_\_\_  
\_\_\_\_\_  
\_\_\_\_\_  
\_\_\_\_\_  
\_\_\_\_\_  
\_\_\_\_\_

\_\_\_\_\_  
\_\_\_\_\_  
\_\_\_\_\_  
\_\_\_\_\_  
\_\_\_\_\_  
\_\_\_\_\_  
\_\_\_\_\_  
\_\_\_\_\_  
\_\_\_\_\_  
\_\_\_\_\_  
\_\_\_\_\_  
\_\_\_\_\_  
\_\_\_\_\_  
\_\_\_\_\_  
\_\_\_\_\_  
\_\_\_\_\_  
\_\_\_\_\_  
\_\_\_\_\_  
\_\_\_\_\_  
\_\_\_\_\_  
\_\_\_\_\_

SWITCHING PROCEDURES DISCUSSED WITH ALL MEMBERS OF CREW:      Y      N

CREW INITIALS \_\_\_\_\_



## 4.8 Transmission Switching Check List

4.8.1 The following basic procedures are for the day of the switching after the outage has been scheduled with and authorized by the RTO System Scheduler (713-207-2196). This applies to the Customer's substation that is directly interconnected with CNP's transmission system.

- Call the RTO System Controller at 281-894-0491 and request a Switching Order
  - Provide name, company affiliation, and telephone number
  - Provide Substation ID
  - Describe reason for request
  - Fill out Switching Order
    - Record the Switching Order number
    - Record start time provided by the RTO System Controller
    - Record the RTO System Controller's name
    - Record the instructions to take equipment OUT
    - Repeat the instructions
- Execute the Switching Order placing Hold Tags where appropriate
- Call the RTO System Controller when the instructions have been completed
  - Report the actual completion time
  - Record the completion time provided by the RTO System Controller on Switching Order
  - Request a Clearance if necessary
    - Provide the number of personnel in the crew
    - Provide the number of and location of grounds
- Verify apparatus is de-energized with a hot line indicator
- Install protective grounds when required
- Perform work
- Remove protective grounds if installed
- Call the RTO System Controller to request to RESTORE equipment
  - Report whether more than one Hold Tag is on any device
  - Provide Clearance number if applicable
    - Provide the number of personnel in the crew clear of the apparatus
    - Provide the number of grounds removed
  - Provide the Switching Order number
  - Fill out Switching Order
    - Record start time provided by the RTO System Controller
    - Record the RTO System Controller's name
    - Discuss performing Switching Order instructions in reverse order
- Alert all personnel to move to a safe distance from apparatus being energized
- Execute the Switching Order removing Hold Tags where appropriate
- Call the RTO System Controller when restoration has been completed
  - Report the actual completion time
  - Record the completion time provided by the RTO System Controller on Switching Order





## 6 Unplanned Outages

### 6.1 Unplanned Outages

- 6.1.1 ERCOT Protocols require that CNP notify ERCOT of all unplanned transmission outages.
- 6.1.2 The Customer shall contact the RTO System Controller as soon as possible whenever any unplanned tripping of any high voltage (60 kV and higher) circuit breaker occurs. CNP crews will be dispatched when high voltage circuit breakers remain open in the Customer's substation that is directly interconnected with CNP's transmission system. CNP crews will reset relay targets except in emergency situations. An "Unplanned Outage Check List" form is included in this procedure.
- 6.1.3 CNP crews are not dispatched when high voltage circuit breakers remain open in a remote, non-CNP substation connected to the Customer's substation, but not directly interconnected with the CNP system. In such a case, the Customer shall discuss and evaluate the event with the RTO System Controller. The Customer shall notify the RTO System Controller prior to any switching.
- 6.1.4 In the event of an unplanned generation outage, the Customer or his designated representative shall advise CNP's RTO System Controller as soon as possible.

### 6.2 Unplanned Outages of 345 kV Facilities Equipped with Ferroresonance Protection

- 6.2.1 Ferroresonance protection is installed whenever a wound PT is connected to a 345 kV and the possibility of a ferroresonance condition occurring exists. If applicable, the Customer shall implement specific procedures for unplanned tripping of 345 kV equipment that has ferroresonance protection installed. Procedures shall include the following:

- Visually inspect the three potential lights located on the control panel inside the control house
- If one or more of the lights are bright and not dim
  - Open all the breaker disconnect switches to isolate the potential transformers
  - Disconnect/Remove the PTs from service on the phases with the bright lights
- If one or more of the lights are dark and not dim
  - Open all the breaker disconnect switches along the affected bus
  - Disconnect/Remove the PTs from service on the phases with the dark lights
- If remote monitoring of potential transformer voltages indicated a ferroresonance condition occurred
  - Open all the breaker disconnect switches to isolate the potential transformers
  - Disconnect/Remove the PTs from service on the phases that indicated ferroresonance
- If all lights are dim
  - Reset the targets on the ferroresonance protection relays
- If relay targets do not indicate proper action
  - Investigate the ferroresonance protection circuit



### 6.3 Emergency Switching

6.3.1 In emergency situations, switching may be performed prior to a CNP crew arriving at the Customer's substation. A qualified person, authorized by the Customer, may operate breakers and switches based upon switching instructions provided by the RTO System Controller. Prior to switching, all relay trip targets shall be reset after the Customer has recorded them and reported them to the RTO System Controller. All personnel shall move to a safe distance from apparatus being energized prior to switching. An "Emergency Switching Check List" form is included in this procedure.

#### 6.3.2 UNPLANNED OUTAGE CHECK LIST

6.3.3 The following instructions are for whenever an unplanned tripping of a transmission service voltage breaker occurs.

- Call the RTO System Controller at 281-894-0491
- Provide the following information to the RTO System Controller
  - Your name, company affiliation, and telephone number
  - Substation ID
  - Nature of the problem
  - Time of outage
  - Status of all breakers and switches (i.e., open, closed, tagged)
  - Cause of the event if known
  - Fault location and faulted equipment if known
  - Fires and their proximity to energized equipment
  - Plant and substation entry constraints (e.g., chemical releases)
- Record the RTO System Controller's name
- Investigate and provide the following information to the RTO System Controller
  - Cause of the event if found during investigation
  - Fault location and faulted equipment if found during investigation
  - Number of trip operations for each breaker (i.e., change in breaker veeder reading)
  - Relay trip and alarm targets - Do not reset targets
- Discuss outage with CNP crews
- CNP crews record and reset relay trip targets
- CNP crews record breaker veeder readings
- Resolve outage and complete any necessary corrective action
  - Call the RTO System Controller at 281-894-0491 to request to RESTORE equipment
  - Record the instructions to RESTORE equipment
  - Repeat the instructions
- Execute the instructions
- Call the RTO System Controller when instructions have been completed

BY: \_\_\_\_\_ DATE: \_\_\_\_\_



## 6.4 EMERGENCY SWITCHING CHECK LIST

6.4.1 The following basic procedures are for emergency situations. Contact the RTO System Controller at one of the following telephone numbers.

- Call the RTO System Controller HOTLINE at 281-894-1625
- Provide the following information to the RTO System Controller
  - Your name, company affiliation, and telephone number
  - Substation ID  Nature of the problem
  - Time of outage
  - Status of all breakers and switches (i.e., open, closed, tagged)
  - Cause of the event if known
  - Fault location and faulted equipment if known
  - Fires and their proximity to energized equipment
  - Plant and substation entry constraints (e.g., chemical releases)
  - Relay trip and alarm targets
- Record the RTO System Controller's name
- Record the instructions to RESTORE equipment
- Reset relay trip targets
- Execute the instructions
- Call the RTO System Controller at 281-894-0491 when instructions have been completed

BY: \_\_\_\_\_ DATE: \_\_\_\_\_.

## 6.5 Other Emergency Conditions

6.5.1 Customer substations are an integral part of the interconnected transmission system and disabling them has an impact on the electrical grid. In certain emergency situations, the Customer may evacuate or shut down their facility. In such cases, the Customer shall endeavor to keep the portion of their substation that is directly connected to the transmission grid in service, unless specifically directed otherwise by the RTO System Controller or ERCOT. The Customer shall not disable A/C power to the DC battery system charger or any protection system components, unless specifically directed otherwise by the RTO System Controller.



## 7 Generation Operation

### 7.1 Applicability

- 7.1.1 This section applies only if the Customer operates electric generating facilities and participates in the wholesale transmission market. The Customer shall follow the ERCOT Operating Guides and ERCOT Protocols or other regulatory requirements that apply to their facilities.

### 7.2 Unit Operation

- 7.2.1 Where CNP owns the interconnecting substation and there is not an in-line breaker to synchronize a generating unit, the Customer has control of CNP's substation breakers that are functioning as generator breakers. CNP has operational control of the disconnect switches associated with these breakers.
- 7.2.2 The Customer shall have generation control personnel on duty at the generating unit site at all times that the generating units are on-line.
- 7.2.3 The Customer or Customer's representative shall notify the RTO System Controller (281-894-0491) immediately before a unit is synchronized and connected to CNP's transmission system.
- 7.2.4 The Customer shall operate units to support the transmission system voltage by regulating reactive power output up to levels demonstrated in the ERCOT tests as required in the ERCOT Protocols. The Customer shall maintain the ERCOT specified voltage level unless otherwise directed by the RTO System Dispatcher or ERCOT.
- 7.2.5 The Customer's voltage regulators, speed governors, and power system stabilizers, if required by ERCOT, shall be in service whenever generating units are on-line. The Customer shall immediately notify ERCOT whenever a voltage regulator, speed governor, or power system stabilizer is taken out of service or placed back in service. The Customer shall maintain settings as close as practical to five percent speed regulation.
- 7.2.6 The Customer shall maintain generating units on-line during system frequency and voltage excursions per ERCOT Operating Guides: [www.ercot.com/mktrules/guides/noperating/cur](http://www.ercot.com/mktrules/guides/noperating/cur).





## 8 Protective Relaying and Control

### 8.1 Settings for Relays Installed for the Protection and Automatic Reclosing of CNP Transmission Lines

8.1.1 CNP calculates and implements all settings for the Customer's relays installed for the protection and automatic reclosing of CNP transmission lines and for the Customer's relays installed to prevent back-energizing CNP's system from generation installed on the low side of the Customer's power transformers. On a case-by-case basis, CNP may issue settings for other relays owned by the Customer. The relay settings implemented by CNP for the Customer's relays will be provided to the Customer upon request.

### 8.2 Applicable Relay Settings

8.2.1 The Customer shall provide CNP with the settings of the Customer's relays that trip or close the Customer's high voltage (60 kV and higher) circuit breakers. The Customer shall provide to the Transmission Accounts representative any proposed settings changes for such relays for CNP's review.

### 8.3 Communications Connections to Electronic Devices

8.3.1 An electronic device that can directly or indirectly trip a circuit breaker connected to a CenterPoint Energy transmission circuit (i.e., transmission line protective relay, transformer bus protective relay, local breaker failure relay, etc.) is not allowed to be monitored via routable protocol communication (i.e., Ethernet), serial or dial-up communication by customers connection directly to the device. Data from these electronic devices can be provided to the customer via the CenterPoint Energy SCADA RTU (CenterPoint Energy 007-400-02 Specification for Remote Telemetry of a Customer-Owned Facility) or the customer may install separate devices for monitoring purposes.

### 8.4 Maintaining Levels of Protection

8.4.1 The Customer shall not disable a single level, or multiple levels, of protection that results in no protection for an energized element, such as, a transmission line, high voltage bus, or transformer.

8.4.2 The Customer shall immediately notify the RTO System Controller whenever the Customer becomes aware of an energized element that has no protection.

8.4.3 The Customer shall immediately notify the RTO System Controller of a protective relay "CPU Failure" alarm or when a protective relay is found powered down, or out of service.



## 9 Equipment Additions, Replacement, Upgrades and Removal

### 9.1 Equipment Changes

- 9.1.1 The Customer shall notify the Transmission Accounts representative with sufficient notice to meet the timeline and data reporting requirements in Table 2 below when equipment additions or removals are planned or when high voltage equipment or associated equipment requires modification or replacement. The Customer shall notify the Transmission Accounts representative prior to performing functional testing and allow CNP to witness the testing.
- 9.1.2 The Customer shall provide equipment and installation, including testing and inspections, per applicable CNP specifications and bill of materials. The Customer shall provide necessary details, such as drawings, specifications, and manufacturer type and catalog number, for CNP's review. All CNP comments shall be incorporated or resolved before any equipment or materials are procured or any work is begun.
- 9.1.3 ERCOT Protocols require that all changes to equipment rated at 60 kV and above be communicated by CNP to ERCOT prior to the in-service date as specified in Table 2 below.
- 9.1.4 ERCOT only approves energization requests when the transmission element is satisfactorily modeled in the ERCOT Network Operations Model.

### 9.2 Modification, Repair, and Replacement of Customer Equipment

- 9.2.1 CNP notifies the Customer of problems in their facilities of which CNP becomes aware. The Customer shall provide any needed equipment modifications, repairs, or replacement as soon as practicable. The Customer shall replace equipment that CNP demonstrates is no longer maintainable. On a case-by-case basis, the Customer and CNP shall develop the responsibilities for the modification, repair, and replacement of this equipment.
- 9.2.2 Industry experience may dictate that certain equipment be modified, repaired, or replaced due to manufacturing defects or unacceptable failure rates and consequences. The Customer shall, as soon as practicable, modify, repair, or replace equipment based on product service advisories issued by manufacturers or advisories issued by CNP.



### 9.3 Customer Substation Equipment Additions, Relocations, Upgrades and/or Removals

When installing, relocating, or upgrading transmission system equipment, Customers must contact their appropriate CNP Transmission Accounts representative with sufficient notice to meet the timelines and data requirements shown below. ERCOT Nodal Protocols Section 3.10.1 requires that all changes to transmission equipment energized at 60 kV and above be communicated by CNP to ERCOT using the Network Operations Model Change Request (“NOMCR”) process as summarized below:

**Table 2**

<b>Target Physical Equipment In-Service Month</b>	<b>Deadline to Submit to RTO</b>	<b>Timeline to Submit initial information to Transmission Accounts Rep</b>
Month of January	<b>Sept. 1</b>	June 1 (prior year)
Month of February	<b>Oct. 1</b>	July 1 (prior year)
Month of March	<b>Nov. 1</b>	August 1 (prior year)
Month of April	<b>Dec. 1</b>	September 1 (prior year)
Month of May	<b>Jan. 1</b>	October 1 (prior year)
Month of June	<b>Feb. 1</b>	November 1 (prior year)
Month of July	<b>Mar. 1</b>	December 1 (prior year)
Month of August	<b>Apr. 1</b>	January 1
Month of September	<b>May 1</b>	February 1
Month of October	<b>June 1</b>	March 1
Month of November	<b>July 1</b>	April 1
Month of December	<b>Aug. 1</b>	May 1

(1) Pursuant to the ERCOT Nodal Protocols, CNP requires the following information to meet the deadlines shown above. The NOMCR data requirements include, but are not limited to:

- Completed project expected in-service date
- Equipment ratings
- Device nomenclature will be provided by CNP
- Engineering drawings showing the final configuration.
- Construction sequence with expected energization dates for each piece of equipment.
- Identification of SCADA data points
- Additional data as may be determined by ERCOT

(2) Known outage requests shall be submitted by Real Time Operations with the NOMCR's for each expected energization date.

(3) ERCOT only approves energization requests when the Transmission Element is satisfactorily modeled in the ERCOT Network Operations Model.



## 10 Equipment Maintenance and Testing

### 10.1 CNP Testing

10.1.1 CNP will perform periodic testing of certain Customer-owned equipment if the equipment is installed for the protection of CNP transmission lines. This includes power line carrier tuning and testing of wave traps, tuners, and carrier sets and calibration and testing of relays and fiber optic communication equipment. CNP will perform testing of SCADA transducers that provide real time data to CNP. CNP may designate additional equipment of the Customer for testing by CNP. CNP will label equipment tested by CNP. The test results for the Customer's equipment tested by CNP will be provided to the Customer upon request.

10.1.2 CNP will endeavor to coordinate CNP testing with the Customer's maintenance outages.

10.1.3 CNP transmission line outages are required for CNP to perform testing of applicable wave traps of the Customer.

10.1.4 Outages of approximately ten hours duration for certain Customer facilities are required for CNP's periodic testing of CNP-owned high voltage metering instrument transformers. Transformer outages are required for metering instrument transformers installed on the high side of transformers. A total separation from CNP's system may be required for certain substation configurations.

### 10.2 Customer Maintenance and Testing

10.2.1 The Customer shall perform maintenance on all structures and equipment owned by the Customer. The Customer shall perform testing on all equipment owned by the Customer except for equipment designated by CNP for testing by CNP as noted in Section 10.1 (CNP Testing). The Customer shall maintain equipment logs and test reports, which shall be provided to CNP upon request.

10.2.2 Depending upon ownership, equipment maintained and tested by the Customer may include the following: line surge arresters, potential and current transformers, coupling capacitors, coupling capacitor potential devices, switches (including auxiliary contacts and motors if installed), breakers (bushings, mechanism, tanks), transformers (bushings, surge arresters, main tank, load tap changer, alarms), relays not tested by CNP, and DC battery system equipment.

10.2.3 The Customer shall notify the RTO System Scheduler at least ten (10) business days in advance before performing maintenance and testing on potential or current transformers connected to CNP meters.

### 10.3 Monthly Inspections

10.3.1 The Customer shall perform monthly inspections to include the following as applicable.

- Visual inspection of outdoor equipment including inside control cabinets
- Verify oil levels



- Verify transformer nitrogen blanket pressure
- Verify transformer fan operation
- Verify breaker compressor or hydraulic pump operation
- Drain condensate from breaker mechanism air tanks
- Verify operation of control house heating and air conditioning

#### 10.4 Quarterly, Semi-annual Testing, and Inspection

10.4.1 CNP recommends Total Combustible Gas (“TCG”) testing once every three months on transformers equipped with a nitrogen blanket.

10.4.2 Infrared thermography of high voltage equipment is recommended once every six months.

#### 10.5 DC Battery System

10.5.1 The Customer shall perform periodic DC battery system equipment inspections and maintenance to include the following as applicable.

- Every Month
  - Visually inspect batteries (corroded connections, leaks, cracked cases)
  - Visually inspect chargers
  - Verify and correct water levels
  - Record and verify float voltage
  - Record and verify ground reference voltage
- Every Six Months
  - Clean battery surfaces
  - Check charger ventilation
  - Record and verify cell voltages
  - Perform internal cell resistance testing
  - Measure inter-cell connection resistance
  - Record and verify specific gravity reading
  - Verify float and equalize voltage settings
  - Verify proper operation of chargers and alarms
  - Verify proper operation of high voltage shutdown circuits

#### 10.6 Functional Testing

10.6.1 The Customer shall perform functional trip testing of each high voltage circuit breaker by tripping and closing the breaker from the breaker control switch at least once every year. This breaker tripping may be coordinated with the switching required for maintenance outages.

10.6.2 High voltage circuit breakers equipped with dual trip coils that use a common actuating shaft (e.g., Allis Chalmers, Westinghouse) require special functional testing. The Customer shall perform a test on each breaker by applying trip voltage simultaneously to both trip coils. If the breaker does not immediately trip, the voltage must be quickly removed to avoid damaging the coils. After verifying the wiring, the Customer shall appropriately label the control wiring. The Customer’s maintenance procedures shall include tagging and properly reconnecting trip coil wiring. The Customer shall perform this test whenever a trip coil is replaced or breaker control wiring is modified.

#### 10.7 Special Inspection and Testing



10.7.1 Industry experience may dictate that certain equipment requires special inspection and testing due to manufacturing defects or unacceptable failure rates and consequences. The Customer shall perform special inspection and testing based on product service advisories issued by manufacturers and advisories issued by CNP.



## **11 Plant Design Considerations**

### **11.1 Emergency Systems**

11.1.1 Continuous electric service from utility power systems cannot be guaranteed even for facilities that are connected to a large number of transmission lines. The possibility exists that a total power outage or separation from the utility system may occur. It is important to consider this when plant emergency systems are designed.

### **11.2 Automatic Reclosing**

11.2.1 CNP utilizes automatic reclosing of high voltage circuit breakers following unplanned tripping of CNP transmission lines. CNP endeavors to intentionally delay the initial reclose attempt by at least one second. The Customer is responsible for the separation of necessary motors or other equipment within one second of the tripping.

### **11.3 System Voltage**

11.3.1 Electric service from a utility power system cannot be guaranteed against fluctuations. Voltage sag is a common fluctuation that occurs during the time of a fault. The large majority of faults on a utility transmission system are single line-to-ground faults. With automatic reclosing of circuit breakers, several voltage sags can occur within a one-minute period. Most voltage sags from faults on transmission systems have a very short duration of less than ten cycles with high-speed fault clearing. Another common fluctuation is a transient voltage oscillation that occurs each time a capacitor bank is energized. Equipment, such as motor contractors, adjustable speed drives, programmable logic controllers, and high intensity discharge lamps, can be sensitive to these short duration voltage sags and transient voltage oscillations.

11.3.2 It is important to consider voltage sag "ride-through" for equipment applied to critical processes where nuisance tripping can cause a whole process to shut down. Plant power systems and equipment control systems can be designed or modified to ride-through the most common voltage sags and transient voltage oscillations on utility power systems. CNP will provide additional information upon request.

### **11.4 Electrical Protection Coordination Studies**

11.4.1 If the Customer performs plant electrical protection coordination studies, the Customer may contact a Transmission Accounts representative to request the available CNP system fault current and system impedance at the Customer's facility.

### **11.5 Substation Design Specifications**

11.5.1 The Customer can contact a Transmission Accounts representative to request current CNP specifications and applicable bills of material for new substations and substation equipment additions and replacement.

**Exhibit "G"**  
**Telemetry Specification**

File Description	File
Telemetry Specification	 SPC-007-400-02 REV 10 FINAL 9-19-2017.1



# SPECIFICATION

FOR

REMOTE TELEMETRY OF A CUSTOMER OWNED FACILITY



ELECTRIC ENGINEERING DEPARTMENT

P.O. BOX 1700 HOUSTON, TEXAS 77251

**REFERENCE DRAWINGS:** Latest Revisions of  
 CenterPoint Energy, CNP Drawing No.BSC-007-400-01 SH.3.  
 CenterPoint Energy, Telecom Board drawing 101, 102, 103, 104.

**REFERENCE SPECIFICATIONS:** Latest Revisions of  
 CenterPoint Energy, CNP Specification No. 007-231-14, Customer 138kV Substation  
 Design.

**REFERENCE DOCUMENTS:** Latest Revisions of  
 CenterPoint Energy, Transmission & Substation Outage and Clearance Coordination  
 Procedures.  
CenterPoint Energy, Substation IFC Process.

						<b>CenterPoint Energy</b>			
						Houston Electric			
10	7-26-2017	Revised section 5	CWM	HAL	MDB	WRITTEN	12/30/03	C.W. Mogannam	
9	12-13-2016	Revised sections	CWM	HAL	MDB	CHECKED	12/30/03	R.M. Secrest	
8	12/18/2014	Revised sections 2, 3, 8.	CWM	TVT	MDB	APPROVED	12/30/03	M.W. Furnish	
NO	DATE	REVISION	BY	CH	APP	Page 1 of 11			
						<b>SPC</b>	<b>007</b>	<b>400</b>	<b>02</b>

## CONTENTS

TITLE	PAGE NO.
SCOPE	3
GENERAL	3
SCADA SYSTEM	4
DESIGN, LAYOUT AND PHYSICAL CRITERIA	5
COMMUNICATION LINES & TELEMETRY TRANSPORT	6
CALIBRATION AND MAINTENANCE	8
CURRENT TRANSFORMERS AND POTENTIAL TRANSFORMERS	8
DRAWING APPROVAL	8
TABLE 1 – ACCEPTABLE TRANSDUCERS AND TEST SWITCHES	9
LIST OF ABBREVIATIONS USED IN FIGURES	10
FIGURE 1 – BREAKER CONTROL AND STATUS WIRING	11

<b>CenterPoint Energy</b>			
Houston Electric			
WRITTEN	12/30/03	C.W. Mogannam	
CHECKED	12/30/03	R.M. Secrest	
APROVED	12/30/03	M.W. Furnish	
Page 2 of 11			
	<b>SPC</b>	<b>007</b>	<b>400 02</b>

## 1. SCOPE

- 1.1. This specification defines the requirements for the engineering, installation, calibration, and commissioning of a Supervisory Control and Data Acquisition (SCADA) Remote Terminal Unit (RTU) and Metering Telemetry, as applicable, at a customer owned facility on the CenterPoint Energy (CNP) transmission system.

## 2. GENERAL

- 2.1. Installation of a CNP owned SCADA RTU in customer-owned facilities is required for all new transmission substations. Existing customer substations originally connected without SCADA monitoring will be required to install SCADA when there is a significant change in the topology of the substation or as directed by ERCOT.
- 2.2. All equipment and work covered by this specification shall be designed, constructed, and tested in accordance with the latest revisions or editions of industry requirements in effect at the time of fabrication. Industry requirements include the applicable codes, standards, specifications, regulations, tests, and procedures of all federal, state and local laws, and include (but are not limited to) the following:
- 2.2.1. American National Standards Institute (ANSI)
- 2.2.2. IEEE formerly the Institute of Electrical and Electronics Engineers, Inc.
- 2.2.3. National Electrical Manufacturers Association (NEMA)
- 2.2.4. Occupational Safety and Health Administration (OSHA)
- 2.2.5. Federal Communications Commission (FCC)
- 2.3. In the event of conflicting requirements, the order of precedence shall be this specification, other referenced CNP specifications, and the standards referenced in section 2.2.
- 2.4. CNP will specify and install the SCADA RTU and associated SCADA equipment. The SCADA RTU will be in a locked cabinet installed in the customer substation control cubicle. The customer must provide interface equipment such as electronic panel meters, transducers, status and alarm contacts, cabling, terminal blocks, and conduit to provide the data required in this specification.
- 2.5. The customer must also install and maintain voice communication equipment in the customer substation control cubicle.
- 2.6. CNP will specify, install and maintain a locked Substation Communications cabinet(s) inside the customer control cubicle for SCADA, metering, and other CNP communications needs.
- 2.7. Communications to substation protection devices for CNP SCADA monitoring shall be serial. Substation electronic devices that can directly or indirectly trip a circuit breaker connected to the CNP transmission circuit (i.e. transmission line protective relay, transformer bus protective that includes breaker failure relaying, etc.) are not allowed to be monitored by the customer. Data can be provided to the customer from a serial port on the CenterPoint Energy SCADA RTU. .
- 2.8. Equipment specified may be substituted with written approval from CNP Substation Engineering and System Protection.
- 2.9. All equipment, engineering and installation shall be furnished by the customer unless otherwise noted in this specification or separate agreements.
- 2.10. Generating facilities will have additional data that is covered below and will be defined in the Standard Generating Interconnection Agreement.

<b>CenterPoint Energy</b>			
Houston Electric			
WRITTEN	12/30/03	C.W. Mogannam	
CHECKED	12/30/03	R.M. Secrest	
APROVED	12/30/03	M.W. Furnish	
Page 3 of 11			
	<b>SPC</b>	<b>007</b>	<b>400 02</b>

2.11. This specification covers the requirements between the customer and CenterPoint Energy and is not meant to cover any additional requirements that the Customer may have with ERCOT.

### 3. SCADA SYSTEM

- 3.1. The SCADA RTU is composed of three subsystems: (1) analog, (2) status, and (3) control.
- 3.2. Analog Subsystem: Analog Data is typically gathered from Intelligent Electronic Devices (IEDs) or transducers. IEDs include Electronic Meters and microprocessor relays. Communication to various IEDs shall be serial, via DNP3 or Modbus protocols. If transducers are used, CNP will determine the transducer electrical requirements. See Table 1 for acceptable transducer models. Meter test switches are required for the transducer current and voltage connections. The customer shall provide an electrical relaying and metering one-line diagram of the proposed customer-owned substation for review by CNP.
- 3.2.1. Customer Substation Analog Telemetry Requirements for substations that sectionalize the CNP system or tap substation as applicable.
- 3.2.1.1. Kilovolts for transmission level voltages (i.e. two line positions or two substation buses), AØ
- 3.2.1.2. Megawatts for each line position, 3Ø
- 3.2.1.3. Megavars for each line position, 3Ø
- 3.2.1.4. Megawatts for each substation load and/or substation transmission level transformer, 3Ø
- 3.2.1.5. Megavars for each substation load and/or substation transmission level transformer, 3Ø
- 3.2.2. CNP will require the following additional analog data for Generating facilities:
- 3.2.2.1. Generator terminal voltage for each generator bus, A phase only
- 3.2.2.2. Megawatts (net preferred) for each generator unit, 3Ø
- 3.2.2.3. Megavars (net preferred) for each generator unit, 3Ø
- 3.2.2.4. Frequency for each generator unit
- 3.2.2.5. Data from the plant electrical load EPS meters (watts, vars, watt-hour from each meter)
- 3.3. Status Subsystem: The status subsystem of the SCADA RTU shall consist of the following.
- 3.3.1. Status of selected transmission voltage circuit breakers or other devices directly affecting the CNP electrical system, as determined by CNP Real Time Operations (RTO). Status shall be derived from either an isolated auxiliary "a" contact in the breaker or monitoring a trip coil of the breaker. Refer to Figure 1 for Breaker Status Connection using trip coil monitoring method.
- 3.3.2. Indication of low voltage and battery charger failure is required for the 130 VDC battery system(s). Typical charger alarms include the following: low voltage, high voltage, loss of AC input, and loss of charger. All these indications shall be combined so that an occurrence of any one of these shall cause a single battery alarm (normally open contact) to the SCADA RTU.
- 3.3.3. SCADA Close Inhibit (SCI) indication is required of breakers controlled by SCADA whenever a lockout relay can inhibit breaker closure by SCADA. A dry, normally open, contact from that relay shall be supplied for SCI indication. Indication contacts from all lockout relays shall be wired in parallel for a single indication in the SCADA cabinet, see Figure 1.
- 3.3.4. Indication of Carrier Tester (CAR) or Pilot (PIL) relaying failure where applicable.
- 3.3.5. Indication for the loss of a potential to a line relay (PT1) that could cause a misoperation of the zone. This alarm is typically generated by a contact from the line relay. Indications from

<b>CenterPoint Energy</b>			
Houston Electric			
WRITTEN	12/30/03	C.W. Mogannam	
CHECKED	12/30/03	R.M. Secrest	
APPROVED	12/30/03	M.W. Furnish	
Page 4 of 11			
	<b>SPC</b>	<b>007</b>	<b>400 02</b>

separate relays will be combined for a single alarm.

3.3.6. Indication of a failed self-check diagnostic of a microprocessor based relay. Designated Relay CPU Fail (RCPU). This alarm is typically generated by a contact from the line relay. Indications from separate relays will be combined for a single alarm.

3.3.7. Cabinet Alarm (CABS) for the SCADA RTU and the CNP Communications Cabinets. This alarm will be generated when the cabinet door is opened.

3.3.8. CNP will require the following additional status signals from the Generating facility:

3.3.8.1. Generator Breaker for each unit

3.3.8.2. Motor operated switches for each unit

3.3.8.3. Generator automatic voltage regulator status (Automatic/Manual).

3.4. Control Subsystem: The control subsystem of the SCADA RTU shall consist of the following:

3.4.1. CNP shall have remote control of all transmission (69kV, 138kV, 345kV) circuit breakers that directly affect the CNP transmission system as determined by CNP Real Time Operations (RTO). Dual remote control (control of a breaker by both the customer's control system and CNP RTO) is not permitted. Figure 1 illustrates how SCADA control will interface with a typical breaker control scheme.

3.4.2. CNP shall have remote control, automatic carrier removal (ATCR), of each pilot relaying scheme. A control contact from the SCADA RTU shall be installed in each pilot circuit. See Figure 1 for typical carrier control circuit.

3.5. All applicable data, listed in Sections 3.2 and 3.3, whether through a CNP-owned RTU, through CNP-connected communication ports, or customer-owned SCADA RTU ports, shall be provided continuously by design. CNP's periodicity for scanning the data from established communication ports and SCADA RTU ports will be set in accordance with the Electric Reliability Council of Texas (ERCOT) requirements.

#### 4. DESIGN, LAYOUT AND PHYSICAL CRITERIA

4.1. SCADA Set Designation: The type of SCADA RTU installed by CNP will depend on the number of controlled breakers.

4.1.1. At ring bus substation or breaker and half substations CNP will typically install a free-standing cabinet 24" wide by 18" deep and 72" tall, with front access. Clearance of 30" in front of the door shall be reserved for maintenance access. Substations with more than four transmission breakers may require a larger cabinet(s). Refer to latest customer RTU drawing submitted by CNP at the project kick-off.

4.1.2. Tap substations will generally require a smaller wall mounted cabinet. The wall mount cabinet is 30" wide by 12" deep and 42" tall. Clearance of 30" in front of the door shall be reserved for maintenance access.

4.1.3. Access to the SCADA RTU cabinet shall be controlled by CNP.

4.2. Connections to the RTU: The Construction Contractor shall install all interconnections between the SCADA RTU and the substation panels.

4.2.1. The customer shall provide a 120 VAC, fifteen (15) amp, dedicated AC power circuit, protected by a fifteen (15) amp circuit breaker, to the SCADA RTU Cabinet for lighting and a convenience outlet.

4.2.2. The customer shall provide a 130 VDC, fifteen (15) amp, dedicated DC power circuit, protected by a fifteen (15) amp circuit breaker, to the SCADA RTU Cabinet for the main RTU power.

4.2.3. All cable shields shall be grounded at a location other than the

<b>CenterPoint Energy</b>			
Houston Electric			
WRITTEN	12/30/03	C.W. Mogannam	
CHECKED	12/30/03	R.M. Secrest	
APROVED	12/30/03	M.W. Furnish	
Page 5 of 11			
	<b>SPC</b>	<b>007</b>	<b>400 02</b>

SCADA RTU Cabinet. Cable shields shall be grounded at one end only.

- 4.3. Cabling: The customer shall size and install all conduit or cable troughs in accordance with ANSI/NFPA 70 (National Electrical Code).

4.3.1. Polyethylene Polyvinylchloride (PEPVC) insulated shielded 2/C #16 cable with stranded copper conductors shall be used for terminations for all transducer outputs.

4.3.2. Breaker controls shall use seven conductor (#12) PEPVC insulated cable with stranded copper conductors for terminations.

Two conductor (#10 or larger) PEPVC insulated cable with stranded copper conductors shall be used for terminations of the AC and DC power circuit.

4.3.3. Status and alarms shall be terminated with two conductor (#16) PEPVC insulated cable with stranded copper conductors.

The customer shall install the necessary conduit or cable management between the SCADA RTU and the relay panels.

- 4.4. Every breaker with 130 VDC SCADA control circuits shall have breaker coil surge suppression. A one hundred (100) ohm, eleven (11) watt resistor (Ohmite style 995-10A) and a Zener diode (Motorola type IN3051A) or equivalent shall be used for this suppression. The series combination of the Zener diode and the resistor shall be parallel to each breaker trip and breaker close coil. States slider-link terminal blocks shall be installed in the breakers for terminating the resistors and Zener diodes. CNP will verify breaker coil surge suppression. See Figure 1.

## Section 5 – Communication Lines and Telemetry Transport

### 5. Communication Lines and Telemetry Transport

- 5.1. The customer shall provide and maintain a direct dial telephone landline for voice communications inside the control house cubicle. The phone shall have an extendable cord such that the handset can be stretched to the front of the relay panels and SCADA RTU so they can be viewed and operated by the person using the phone. The telephone landline must continue to operate during a site power failure.
- 5.2. CNP will provide a Telecom transport option for telemetry backhaul and connectivity using one of the following options: CNP Microwave, CNP Fiber or a Leased Circuit.
- 5.3. If the option is CNP Microwave;
- 5.3.1. CNP will provide tower height and wind load specifications to the customer.
- 5.3.2. The customer shall procure, install, own, and maintain the tower.
- 5.3.3. CNP will procure, install, own and maintain the microwave radio and related equipment
- 5.3.4. The customer shall provide a flame retardant coated 4' x 8' sheet of 3/4" plywood for CNP enclosures.
- 5.3.5. CNP will install a Telecom enclosure on the backboard provided by the customer as shown in CNP Drawing 103, Telecom Board Layout.
- 5.3.6. The customer shall install conduits and cables to the Telecom enclosure for grounding, dedicated 15A 120V AC power, and dedicated 15A 130V DC power as shown in CNP Drawing 103, Telecom Board Layout.
- 5.4. If the option is CNP Fiber;
- 5.4.1. The customer shall provide a path for the fiber to the control cubicle.
- 5.4.2. The path may be either aerial or underground.
- 5.4.3. CNP will provide site specific underground or aerial specifications to the customer in a Statement of Work (SOW).
- 5.4.4. The customer shall install the underground duct or poles for aerial installation.
- 5.4.5. The customer shall install fiber supplied by CNP. CNP will own and maintain the fiber.
- 5.4.6. CNP will terminate the fiber and install fiber distribution panels.

<b>CenterPoint Energy</b>			
Houston Electric			
WRITTEN	12/30/03	C.W. Mogannam	
CHECKED	12/30/03	R.M. Secrest	
APPROVED	12/30/03	M.W. Furnish	
Page 6 of 11			
<b>SPC</b>	<b>007</b>	<b>400</b>	<b>02</b>

- 5.4.7. The customer shall provide a flame retardant coated 4' x 8' sheet of 3/4" plywood for CNP enclosures.
- 5.4.8. CNP will install a Telecom enclosure on the backboard provided by the customer as shown in CNP Drawing 103, Telecom Board Layout.
- 5.4.9. The customer shall install conduits and cables to the Telecom enclosure for; grounding, dedicated 15A 120V AC power, and dedicated 15A 130V DC power as shown in CNP Drawing 103, Telecom Board Layout.
- 5.5. If the option is leased circuit
  - 5.5.1. The customer shall provide a flame retardant coated 4' x 4' sheet of 3/4" plywood space for the Telco demark inside the control cubicle.
  - 5.5.2. The customer shall provide a flame retardant coated 4' x 8' sheet of 3/4" plywood for CNP enclosures.
  - 5.5.3. CNP will install a Telecom enclosure to be mounted on the backboard provided by the customer as shown in CNP Drawing 103, Telecom Board Layout.
  - 5.5.4. The customer shall install conduits and cables to the Telecom enclosure for; grounding, dedicated 15A 120V AC power, and dedicated 15A 130V DC power as shown in CNP Drawing 103, Telecom Board Layout.
  - 5.5.5. The customer shall provide dedicated 15A 120V AC power and grounding to backboard. See CNP Drawing 104, Third Party Telco Board Design.

## 6. CALIBRATION AND MAINTENANCE

- 6.1. After all equipment necessary for remote telemetry has been installed, CNP personnel will calibrate and verify operation of all equipment installed per this specification.
- 6.2. The RTU and transducers installed per this specification will be maintained by CNP unless otherwise noted in an agreement with the customer. Maintenance will include accuracy checks, recalibration and replacement/repair of equipment when needed.
- 6.3. CNP shall furnish locks that will remain in series with customer locks to permit access to all switchyard gates, substation control cubicle door(s), and disconnect switches.

## 7. CURRENT TRANSFORMERS AND POTENTIAL TRANSFORMERS

- 7.1. The current transformers (CTs) and potential transformers (PTs) necessary for transducers and meter circuits itemized in this specification shall be provided according to CNP specification 007-231-14. If a particular application is not covered by this specification, then CNP will designate the necessary PT(s) and CT(s) on the substation one-line diagram that the customer submits for comment and approval.
- 7.2. For some substation layouts a potential rollover circuit shall be needed. If a potential rollover circuit is needed, it will be designated by CNP on the one-line diagram that the customer submits for comment and approval.

<b>CenterPoint Energy</b>			
Houston Electric			
WRITTEN	12/30/03	C.W. Mogannam	
CHECKED	12/30/03	R.M. Secrest	
APPROVED	12/30/03	M.W. Furnish	
Page 7 of 11			
	<b>SPC</b>	<b>007</b>	<b>400 02</b>

**8. DRAWING APPROVAL**

- 8.1. The Engineering Contractor shall provide electronic and paper copies of all drawings showing equipment connections and structural details of all equipment associated with SCADA installation as per the CenterPoint Energy Substation IFC Process document.
- 8.2. Drawings required by this specification include:
1. Substation one-line relaying and metering diagrams illustrating the overall telemetry scheme,
  2. Substation control cubicle layout(s) and floor plan(s),
  3. Conduit and cable lists
  4. Conduit Layout or Plan and Profile
  5. RTU manufacturers prints and customer connections
  6. AC Schematics for all power and control circuits,
  7. AC Relaying Schematics (Electrical Three-Line),
  8. Relay panel layouts,
  9. Bill of material for items required by this specification,
  10. Battery charger alarm relay(s) schematics,
  11. AC & DC Distribution Panels,
  12. Communication cable and conduit routing through customer facility,
  13. Customer Facility Plot Layout,

<b>CenterPoint Energy</b>			
Houston Electric			
WRITTEN	12/30/03	C.W. Mogannam	
CHECKED	12/30/03	R.M. Secrest	
APROVED	12/30/03	M.W. Furnish	
Page 8 of 11			
	<b>SPC</b>	<b>007</b>	<b>400 02</b>



<b>DESCRIPTION</b>	<b>MANUFACTURER</b>	<b>MODEL NO.</b>	<b>MONITORING POINTS</b>
VOLTAGE TRANSDUCER	AMETEK SCIENTIFIC COLUMBUS	VT110A4	ONE PER SUBSTATION BUS
TEST SWITCH SINGLE PHASE	DURHAM	2-1022F-03	ONE PER EACH TRANSDUCER
WATT/VAR TRANSDUCER SINGLE PHASE	AMETEK SCIENTIFIC COLUMBUS	XLWV5C5	ONE PER EACH LINE OR LOAD
WATT/VAR TRANSDUCER THREE PHASE	AMETEK SCIENTIFIC COLUMBUS	XLWV342K5A4	ONE PER EACH LINE, GENERATOR OR LOAD
TEST SWITCH THREE PHASE	DURHAM ABB MEGA POWER SYS STATES	2-1058F-00 FS3A171171001NULL CS3A-556-556-162 FMS #293R-330JF-ST	ONE PER EACH TRANSDUCER

**Table 1 ACCEPTABLE TRANSDUCERS AND TEST SWITCHES**

<b>CenterPoint Energy</b> Houston Electric			
WRITTEN	12/30/03	C.W. Mogannam	
CHECKED	12/30/03	R.M. Secrest	
APPROVED	12/30/03	M.W. Furnish	
Page 9 of 11			
	<b>SPC</b>	<b>007</b>	<b>400 02</b>

**LIST OF ABBREVIATIONS USED IN FIGURES**

aN4, aN14 = TYPICAL WIRE NAMES IN CNP CARRIER RELAYING SCHEMES

ATCR = AUTOMATIC CARRIER REMOVAL

C = CLOSE

CS = CONTROL SWITCH

CVE = SYNCRO-VERIFIER RELAY

ICR = INDICATION CONTROL RELAY

N 11, N21 = TYPICAL WIRE NAMES IN CNP RECLOSE REMOVAL SCHEMES

NO = NORMALLY OPEN

OC = BREAKER CLOSE COTL

RC = AUTOMATIC RECLOSING RELAY

RR = RECLOSE REMOVAL LATCHING RELAY

T = TRIP

TC = BREAKER TRIP COIL

X, Y = AUXILIARY COILS OF RC RELAY

SSS = SLIDER-LINK TERMINAL

R = RESISTOR

DDD = ZENER DIODE

AMS = AUTOMATIC / MANUAL THROWOVER SWITCH

<b>CenterPoint Energy</b>			
Houston Electric			
WRITTEN	12/30/03	C.W. Mogannam	
CHECKED	12/30/03	R.M. Secrest	
APROVED	12/30/03	M.W. Furnish	
Page 10 of 11			
	<b>SPC</b>	<b>007</b>	<b>400 02</b>

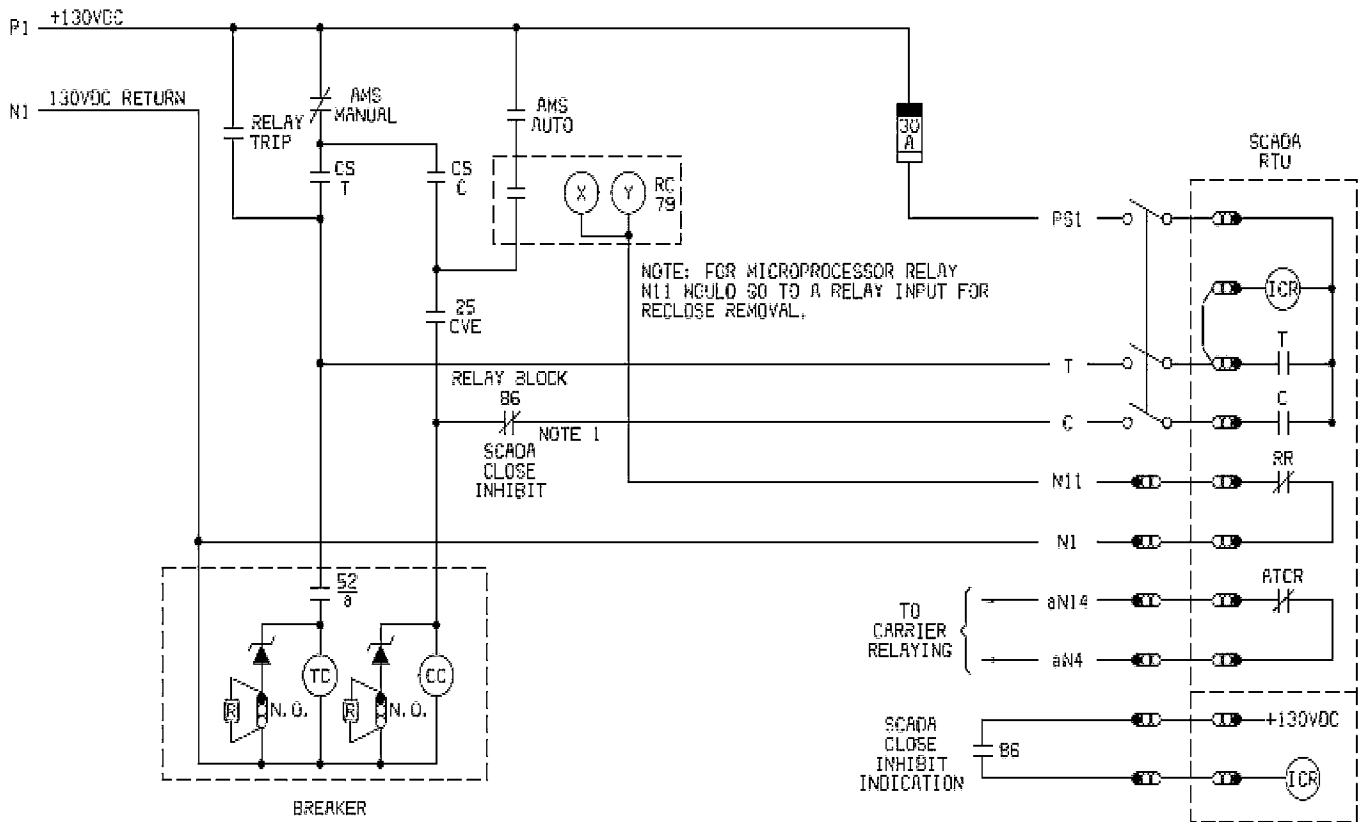



Figure 1



LEGEND

- RR = RECLOSE REMOVAL LATCHING RELAY INSIDE SCADA
- ATCR = AUTOMATIC CARRIER REMOVAL
- ICR = INDICATION CONTROL RELAY MONITORS STATUS OF A SWITCH
- SCI = SCADA CLOSE INHIBIT
-  - DISCONNECTING TERMINAL BLOCK, DARK END IS TOP, LINK OPENS DOWN
-  - FUSE

NOTE: 1.) RELAY BLOCK CONTACT SHOWN COULD REPRESENT SEVERAL CONTACTS IN SERIES

		<b>CenterPoint Energy</b>	
		Houston Electric	
WRITTEN	12/30/03	C.W. Mogannam	
CHECKED	12/30/03	R.M. Secrest	
APPROVED	12/30/03	M.W. Furnish	
		Page 11 of 11	
SPC	007	400	02

**Exhibit “H”  
Attached Drawings**

File Description	File
138kV One Line Relaying & Metering Diagram	 Inverter Field Solar IPP FS R&M 02-04-20.
138kV Development Plan	 Inverter Field Solar IPP FS DP 02-04-2020.